



City of Chattanooga

Mayor Tim Kelly

January 31, 2023

VIA CERTIFIED MAIL

Mr. Richard Elliott
Environmental Engineer
Clean Water Enforcement Branch
US EPA-Region 4
61 Forsyth Street, SW
Atlanta, GA 30303

**Re: *United States of America et. al. v. City of Chattanooga, No. 1:12-cv-0024*
Annual Work Progress Report No. 16 – January 2022 to December 2022**

Dear Mr. Elliott:

On behalf of the City of Chattanooga, Tennessee ("City"), and in accordance with the consent decree entered by the United States District Court for the Eastern District of Tennessee (Southern Division), on April 24, 2013, in the case styled the United States of America et. al. v. City of Chattanooga, No. 1:12-cv-0024 ("Consent Decree"), we are submitting to both the Environmental Protection Agency ("EPA") and the Tennessee Department of Environment and Conservation ("TDEC") the sixteenth annual work progress report required pursuant to paragraph 39 of the Consent Decree. This report is also being submitted in accordance with the letter from Denise Diaz, dated September 16, 2013, establishing the dates for reporting under the Consent Decree.

I certify under penalty of law that this document and all attachments were prepared under my direction or supervision in accordance with a system designed to assure that qualified personnel properly gather and evaluate the information submitted. Based on my inquiry of the person or persons who manage the system, or those persons directly responsible for gathering such information, the information submitted is, to the best of my knowledge and belief, true, accurate and complete. I am aware that there are significant penalties for submitting false information, including the possibility of fine and imprisonment for knowing violations.

Mr. Richard Elliott
January 31, 2023
Page Two

Please let me know if you have any questions regarding our submittal.

Sincerely,

Mark Heinzer

Mark Heinzer (Jan 30, 2023 13:38 EST)

Mark Heinzer, P.E.
Interim Administrator, Wastewater Department

Enclosure

cc: Karl Fingerhood, Esq., US DOJ
Chief, Environmental Enforcement Section, US DOJ
Chief, Clean Water Enforcement Branch, US EPA Region 4
Paul Schwartz, Esq., US EPA
Sohnia Hong, Office of the Attorney General
Enforcement Coordinator, Water Pollution Control, TDEC
Brandi Prewitt, TN Clean Water Network
Adam Sowatzka, Esq., King & Spalding
Mike Marino, P.E., Jacobs Engineering
Xavier Pedoux, P.E., Jacobs Engineering



Annual Work Progress Report No. 16

January 1 – December 31, 2022

Prepared for

**Environmental Protection Agency and
Tennessee Department of Environment and
Conservation**

City of Chattanooga
Wastewater Department
Consent Decree Program
Case No. 1:12-cv-00245

Prepared by

City of Chattanooga
Wastewater Department

Submitted by

Jacobs
Jacobs Engineering Group Inc.
Consent Decree Program Manager

Chattanooga, Tennessee

January 31, 2023

Contents

	Appendix	iii
1.0	Executive Summary	1
2.0	Introduction	4
	2.1 Purpose	4
	2.2 Requirements	4
	2.3 Report Structure	4
3.0	Work Progress.....	6
	3.1 Capacity, Management, Operations and Management (“CMOM”) Programs (¶20) (completed)	6
	3.1.1 CMOM-Sewer Overflow Response Protocol (“SORP”) (¶20.a) (completed)	6
	3.1.2 CMOM-Emergency Response Plan (¶20.b) (completed)	6
	3.1.3 CMOM-FOG Mgmt. Plan (¶20.c) (completed).....	6
	3.1.4 CMOM-Gravity Line Preventive Maintenance Program (“GLPMP”) (¶20.d) (completed).....	6
	3.1.5 CMOM-PS Operations Program (“PSOP”) (¶20.e) (completed).....	6
	3.1.6 CMOM-PS Preventive Maintenance Program (“PSPMP”) (¶20.f) (completed).....	6
	3.1.7 CMOM-Hydraulic Model Development (¶20.g) (completed).....	6
	3.1.8 CMOM-Capacity Assurance Program (“CAP”) (¶20.h) (completed)	6
	3.1.9 CMOM-Inter-Jurisdictional Agreement (“IJA”) Program (¶20.i) (completed)	7
	3.2 Sanitary Sewer Evaluation Study (“SSES”) Work Plan (¶21).....	7
	Phase I SSES (¶21.b) (completed)	7
	3.2.1 Focused SSES and Rehabilitation-Chattanooga Creek 4 (completed)	7
	3.2.2 Focused SSES and Rehabilitation-Dobbs Branch 3 (completed).....	7
	3.2.3 Focused SSES and Rehabilitation-South Chickamauga Creek 1 (completed).....	7
	3.2.4 Focused SSES and Rehabilitation-South Chickamauga Creek 5 (completed).....	7
	3.2.5 Focused SSES and Rehabilitation-South Chickamauga Creek 16 (completed).....	7
	Phase II SSES (¶21.b).....	8
	3.2.6 Focused SSES and Rehabilitation-Tennessee River 10 (completed)	8
	3.2.7 Focused SSES and Rehabilitation-Dobbs Branch 6 (completed).....	8
	3.2.8 Focused SSES and Rehabilitation-Friars Branch 13 (completed).....	8
	3.2.9 Focused SSES and Rehabilitation-Mackey Branch 5 (completed).....	8
	3.2.10 Focused SSES and Rehabilitation-Tennessee River 8 Sewer Improvements	8
	3.2.11 Focused SSES and Rehabilitation-South Chickamauga Creek 9 & Chattanooga Creek 6.....	8
	3.2.12 Focused SSES and Rehabilitation-Tennessee River 5	9

3.3	Early Action Capital Improvement Projects (¶22)	9
3.3.1	SSO and Wet Weather Volume Reduction Projects	9
3.3.2	MBWWTP Projects (completed)	11
3.3.3	CSO Projects (completed)	11
3.3.4	Operations Projects (completed)	12
3.4	East Bank/West Bank Outfall Assessment and Rehabilitation Plan (¶23).....	12
3.4.1	East Bank/West Bank Outfall Assessment and Rehabilitation Plan	12
3.5	Long Term Control Plan (“LTCP”) Updates (¶24)	12
3.5.1	LTCP-Additional Operational Plan (“AOP”) for Chattanooga Creek CSO Outfalls (¶24.a) (completed).....	12
3.5.2	LTCP – AOP Implementation (¶24.a) (completed).....	12
3.5.3	LTCP-Post Construction Compliance Monitoring Program (¶24.b) (completed).....	13
3.5.4	Maximizing Treatment at MBWWTP (¶24.c).....	13
3.6	MBWWTP Process Controls Program (¶25) (completed).....	13
3.7	Green Infrastructure (“GI”) Program Plan for CSS Basins (¶26) (completed)	14
3.8	Civil Penalty (¶28-30) (completed)	14
3.8.1	Cash Payment (completed)	14
3.8.2	Highland Park GI Demonstration Project (completed).....	14
3.9	Agawela Drive Stream Restoration – SEP (¶31-37) (completed)	14
3.10	Reporting Requirements (¶38-45).....	14
3.11	Stipulated Penalties (¶46-55).....	15
4.0	Additional Work (¶39).....	17
4.1	201 Facility Plan Update (completed).....	17
4.2	Citico Pump Station and CSOTF Upgrades (completed).....	17
4.3	South Chick Pump Station Phase II and Spring Creek Pump Station Upgrades (completed)	17
4.4	Carter Street Sewer Rehabilitation (completed)	17
4.5	MBWWTP-Control Room Upgrades (completed)	17
4.6	MBWWTP – Detritors Rehabilitation (completed).....	18
4.7	Implementation of CD GI Projects in the CSS (completed)	18
4.8	Friar’s Branch-South Chick Creek 5 Interceptor Rehabilitation (completed)	18
4.9	Citico Pump Station Reliability Improvements (completed)	18
4.10	MBWWTP Secondary Clarifier Upgrades and Additions (completed).....	18
4.11	CSOTF Study (completed).....	18
4.12	South Chickamauga Interceptor Improvements – Phase 1 (completed).....	18
4.13	Focused SSES and Rehabilitation-South Chickamauga Creek 1 – Phase 2 (completed)	18
4.14	Critical Pump Station Improvements Master Plan (completed).....	19
4.15	Lupton Drive Chronic SSO Elimination Project (completed)	19
4.16	Brainerd Golf Course Pump Station Safety Upgrade.....	19
4.17	Pump Station Improvements – Hixson 2	19
4.18	Wet Weather Combined Sewer Storage – Phase 1, 2 & 3	19
4.19	CSOTF Improvements – Phase 1	20
4.20	CSOTF Equipment Replacement Program	20
4.21	Dobbs Branch Basin Improvements – Phase 1	20
4.22	Dobbs Branch Basin Improvements – Phase 2	20

4.23	Wet Weather Storage Phase 4 – South Chickamauga Pump Station.....	21
4.24	Citico Pump Station Improvements	21
4.25	Riverview Park/CGCC Chronic SSO Elimination Project.....	21
4.26	South Chick Creek 2, 3, & 4 Interceptor Rehab.....	21
4.27	Tiftonia Pump Station 1 Safety Upgrade	21
4.28	ISS Capacity Improvements – Creekside Preserve.....	22
4.29	Wet Weather Storage Phase 6 – Hixson Pump Station 1	22
4.30	Environmental and Economic Infrastructure Improvement Plan (“E2I2”) SSO Abatement Program	22
4.31	Tiftonia Pump Station 2 Safety Upgrade	23
4.32	MBWWTP SCADA Master Plan – Phase 1 - 3	23
4.33	MBWWTP Improvements – Centrifuge Upgrades	23
4.34	Citico Force Main Rehabilitation.....	23
4.35	Mountain Creek Pump Station Improvements (completed)	24
4.36	Big Ridge #5 Pump Station Improvements.....	24
4.37	Big Ridge #2 Pump Station Improvements.....	24
4.38	Highland Park Pump Station Improvements.....	24
4.39	Lookout Creek Sewer Basin Master Plan (completed)	25
4.40	MBWWTP Wet Weather Response Team (completed).....	25
4.41	Selected Pump Station Safety Upgrades	25
4.42	23 rd Street Pump Station Improvements.....	25
4.43	Influent Pump Station Improvements (IPS Screen Bypass).....	25
4.44	Central Avenue Sewer Improvements (Prev. Lupton City Sewer Rehab)	26
4.45	Winterview Pump Station and Basin Improvements	26
4.46	Tiftonia Pump Station #3 Improvements	26
4.47	South Chickamauga Pump Station Improvements	26
4.48	Green Infrastructure – Lincoln Park	27

Appendix

A Project Schedules Gantt Chart

Tables

1-1	Completed Projects and Submitted Consent Decree Deliverables for the Current Reporting Period	1
1-2	Anticipated Completed Projects and Consent Decree Deliverables for the Next Reporting Period.....	2

Acronyms and Abbreviations

ARAP	Aquatic Resource Alteration Permit
CAP	Capacity Assurance Program
CD	Consent Decree
CIPP	Cured in Place Pipe
CMOM	Capacity, Management, Operations, and Management
CSO	Combined Sewer Overflow
CSOTF	Combined Sewer Overflow Treatment Facility
CSS	Combined Sewer System
EFT	Electronic Funds Transfer
EPA	Environmental Protection Agency
ESIP	Enterprise South Industrial Park
FOG	Fats, Oils, and Grease
FSE	Food Service Establishments
GLPMP	Gravity Line Preventative Maintenance Program
HVAC	Heating, Ventilation, and Air Conditioning
I/I	Inflow and Infiltration
IPS	Influent Pump Station
ISS	Interceptor Sewer System
LF	Linear Feet
LTCP	Long Term Control Plan
MBWWTP	Moccasin Bend Wastewater Treatment Plant
MBEC	Moccasin Bend Environmental Campus
MCC	Motor Control Center
MGD	Million Gallons per Day
N/A	Not Applicable
NOAA	National Oceanic and Atmospheric Administration
NPDES	National Pollution Discharge Elimination System

NTP	Notice to Proceed
PCP	Process Controls Program
PCCMP	Post Construction Compliance Monitoring Program
PDR	Public Document Repository
PLC	Programmable Logic Controller
PS	Pump Station
PSOP	Pump Station Operations Program
PSPMP	Pump Station Preventive Maintenance Program
RDII	Rain-derived Infiltration and Inflow
RFQ	Request for Quotation
SCADA	Supervisory Control and Data Acquisition
SOP	Standard Operating Procedure
SORP	Sewer Overflow Response Protocol
SRF	State Revolving Funds
SSES	Sanitary Sewer Evaluation Study
SSO	Sanitary Sewer Overflow
SUO	Sewer Use Ordinance
TCWN	Tennessee Clean Water Network
TDEC	Tennessee Department of Environment and Conservation
TDOT	Tennessee Department of Transportation
USDOJ	United States Department of Justice
VFD	Variable Frequency Drive
WCTS	Waste Collection and Transmission System
WWD	Wastewater Department
WWTA	Wastewater Treatment Authority

1.0 Executive Summary

On April 24, 2013, the City of Chattanooga (“City”) entered into a consent decree with the United States and the State of Tennessee, in the case styled *United States of America et. al. v. City of Chattanooga, No. 1:12-cv-00245* (“CD”). This Annual Work Progress Report (“Report”) has been prepared pursuant to the requirements of paragraph 39 of the CD. In accordance with the CD, this Report presents the major milestones achieved in the last 12 months, and also provides projections for activities anticipated to be completed in the following 12 months. This Report presents milestones achieved from January 1, 2022 through December 31, 2022 (“Report Period”), and the projections cover the period of January 1, 2023 through December 31, 2023.

During the Report Period, the City developed and submitted the deliverables that are listed in Table 1-1 to the Environmental Protection Agency (“EPA”) and the Tennessee Department of Environment and Conservation (“TDEC”) for review and approval. This information is also presented in Gantt chart format in Appendix A.

Table 1-1

Completed Projects and Submitted Consent Decree Deliverables for the Current Reporting Period

CD Projects and Deliverables	CD Reference	CD Deadline	Submittal Date/Completion Date
Quarterly Report No. 34	Section IX., para 38	1/31/2022	1/31/2022
Quarterly Report No. 35	Section IX., para 38	4/30/2022	4/30/2022
Quarterly Report No. 36	Section IX., para 38	7/31/2022	7/31/2022
Quarterly Report No. 37	Section IX., para 38	10/31/2022	10/31/2022
Annual Work Progress Report No. 15	Section IX., para 39	1/31/2022	1/31/2022
Annual Report 9	Section IX., para 40	2/28/2022	3/1/2022
LTCP - AOP Implementation**	Section VI., para 24(a)	6/29/2021***	12/14/2022
Lupton Drive Chronic SSO Elimination Project*	Section IX., para 39(c)	N/A	02/09/2022
Mountain Creek Pump Station Improvements*	Section IX., para 39(c)	N/A	09/30/2022
Lookout Creek Sewer Basin Master Plan*	Section IX., para 39(c)	N/A	11/30/2022

* Additional project per paragraph 39(c) of CD

** A Notice of (Anticipated) Delay was sent to EPA on May 26, 2020, and EPA’s response was received December 16, 2020. A further Notice of (Anticipated) Delay was sent to EPA on June 10, 2022, and EPA’s response was received on September 12, 2022.

Table 1-2 lists the projects and deliverables that the City expects to complete during the upcoming annual period of January 1, 2023 through December 31, 2023. This information is also available in Gantt chart format in Appendix A.

Table 1-2

Anticipated Completed Projects and Consent Decree Deliverables for the Next Reporting Period

CD Projects and Deliverables	CD Reference	CD Deadline	Anticipated Submittal/ Completion Date
Quarterly Report No. 38	Section IX., para 38	1/31/2023	1/31/2023
Quarterly Report No. 39	Section IX., para 38	4/30/2023	4/30/2023
Quarterly Report No. 40	Section IX., para 38	7/31/2023	7/31/2023
Quarterly Report No. 41	Section IX., para 38	10/31/2023	10/31/2023
Annual Work Progress Report No. 16	Section IX., para 39	1/31/2023	1/31/2023
Annual Report 10	Section IX., para 40	2/28/2023	2/28/2023
DuPont PS and Basin Improvements – Phase 2**	Section VI., para 22	6/24/2020**	2/15/2023
Wet Weather Combined Sewer Storage - Phase 1, 2, & 3*	Section IX., para 39(c)	N/A	2/28/2023
Dobbs Branch Basin Improvements - Phase 1*	Section IX., para 39(c)	N/A	3/15/2023
Dobbs Branch Basin Improvements - Phase 2*	Section IX., para 39(c)	N/A	2/15/2023
CSOTF Equipment Replacement Program*	Section IX., para 39(c)	N/A	6/3/2023
CSOTF Improvements - Phase 1*	Section IX., para 39(c)	N/A	9/26/2023
Big Ridge PS #2 Improvements	Section IX., para 39(c)	N/A	12/05/2023

* Additional project per paragraph 39(c) of CD

** A Notice of Delay was sent to EPA on August 23, 2018

This page is intended to be blank.

2.0 Introduction

2.1 Purpose

Pursuant to Section IX, paragraph 39, of the CD, the City is required to submit work progress reports on an annual basis to the EPA and TDEC. Chattanooga has prepared this Report to satisfy this reporting requirement.

2.2 Requirements

As detailed in Section IX of the CD, the City is required to report the following information concerning compliance with the remedial actions set forth under the CD:

1. A description of projects and activities completed and milestones achieved during the previous 12-month period pursuant to the requirements of the CD, in Gantt chart or similar format, including a description of compliance or non-compliance with the requirements of the CD and, if applicable, the reasons for non-compliance;
2. A summary of significant projects and activities anticipated to be performed, and milestones anticipated to be achieved, in the successive 12-month period to comply with the requirements of the CD, in Gantt chart or similar format; and
3. Any additional information the City determines is appropriate to demonstrate that the City is implementing the remedial actions required under the CD in an adequate and timely manner.

2.3 Report Structure

Work progress is presented in the body of the Report in a narrative format. This narrative includes a brief description of each CD project, as well as any activities completed or milestones that were achieved or are anticipated to be completed. In addition to these descriptions, a detailed schedule containing each of the projects in Gantt format is provided in Appendix A.

This page is intended to be blank.

3.0 Work Progress

3.1 Capacity, Management, Operations and Management (“CMOM”) Programs (§20) (completed)

3.1.1 CMOM-Sewer Overflow Response Protocol (“SORP”) (§20.a) (completed)

This project has been completed. See Semi-Annual Work Progress Report No. 5 submitted January 27, 2016.

3.1.2 CMOM-Emergency Response Plan (§20.b) (completed)

This project has been completed. See Semi-Annual Work Progress Report No. 5 submitted January 27, 2016.

3.1.3 CMOM-FOG Mgmt. Plan (§20.c) (completed)

This project has been completed. See Semi-Annual Work Progress Report No. 5 submitted January 27, 2016. A revised FOG Plan was submitted to the EPA on September 28, 2016 and approved on December 7, 2016.

3.1.4 CMOM-Gravity Line Preventive Maintenance Program (“GLPMP”) (§20.d) (completed)

This project has been completed. See Semi-Annual Work Progress Report No. 5 submitted January 27, 2016.

3.1.5 CMOM-PS Operations Program (“PSOP”) (§20.e) (completed)

This project has been completed. See Semi-Annual Work Progress Report No. 5 submitted January 27, 2016.

3.1.6 CMOM-PS Preventive Maintenance Program (“PSPMP”) (§20.f) (completed)

This project has been completed. See Semi-Annual Work Progress Report No. 5 submitted January 27, 2016.

3.1.7 CMOM-Hydraulic Model Development (§20.g) (completed)

This project has been completed. See Semi-Annual Work Progress Report No. 6 submitted July 27, 2016.

3.1.8 CMOM-Capacity Assurance Program (“CAP”) (§20.h) (completed)

This project has been completed. See Semi-Annual Work Progress Report No. 7 submitted January 25, 2017.

3.1.9 CMOM-Inter-Jurisdictional Agreement (“IJA”) Program (§20.i) (completed)

This project has been completed. See Semi-Annual Work Progress Report No. 4 submitted July 24, 2015.

3.2 Sanitary Sewer Evaluation Study (“SSES”) Work Plan (§21)

According to paragraph 21.a. of the Consent Decree, “Within nineteen (19) Months after the Effective Date of this Consent Decree, Chattanooga shall submit to EPA and TDEC for review and comment a SSES Work Plan.” This deliverable was due on November 24, 2014, and Chattanooga submitted it early on November 18, 2014.

Phase I SSES (§21.b) (completed)

EPA approved the SSES Work Plan on July 10, 2015, which required all of the Phase I SSES work (involving the five following sewersheds: Chattanooga Creek 4; Dobbs Branch 3; South Chickamauga Creek 1; South Chickamauga Creek 5; and South Chickamauga Creek 16) to be completed under the plan by July 10, 2020, in accordance with paragraph 21.b. of the Consent Decree. All of the work under the Phase I SSES Work Plan was completed by that date (in fact, it was completed by January 29, 2019) as set forth as follows:

3.2.1 Focused SSES and Rehabilitation-Chattanooga Creek 4 (completed)

This project has been completed. See Semi-Annual Work Progress Report No. 10 submitted July 30, 2018.

3.2.2 Focused SSES and Rehabilitation-Dobbs Branch 3 (completed)

This project has been completed. See Semi-Annual Work Progress Report No. 10 submitted July 30, 2018.

3.2.3 Focused SSES and Rehabilitation-South Chickamauga Creek 1 (completed)

This project has been completed. See Semi-Annual Work Progress Report No. 11 submitted January 29, 2019.

3.2.4 Focused SSES and Rehabilitation-South Chickamauga Creek 5 (completed)

This project has been completed. See Semi-Annual Work Progress Report No. 11 submitted January 29, 2019.

3.2.5 Focused SSES and Rehabilitation-South Chickamauga Creek 16 (completed)

This project has been completed. See Semi-Annual Report No. 5 submitted January 27, 2016. We also note that this work was also completed in conjunction with related work in and adjacent to this basin involving the Early Action Capital Improvement Project #3.3.1.3 below (East Brainerd Collection System and PS Rehabilitation). See Semi-Annual Work Progress Report No. 10 submitted July 30, 2018.

Phase II SSES (¶21.b)

According to paragraph 21.b. of the Consent Decree “SSES Phase II shall be completed for the remaining twenty-four (24) Sewersheds, as shown on the map attached hereto as Appendix A, within fifteen (15) years after EPA’s approval of the SSES Work Plan.” Based on the approval date of the SSES Work Plan by EPA, the due date is July 10, 2030. Chattanooga has begun work on Phase II, as outlined below. Four of these sewersheds have already been completed in Phase I in conjunction with related work in and adjacent to this basin involving Early Action Capital Improvement Projects and others have started. Chattanooga had the opportunity to provide a status update of SSES Phases I and II to EPA on March 9, 2022.

3.2.6 Focused SSES and Rehabilitation-Tennessee River 10 (completed)

This project was completed as part of Early Action Capital Improvement Project #3.3.1.1 below (DuPont Pump Station and Basin Improvements – Phase 1).

3.2.7 Focused SSES and Rehabilitation-Dobbs Branch 6 (completed)

This project was completed as part of Early Action Capital Improvement Project #3.3.1.7 below (Highland Park Sewer Rehabilitation).

3.2.8 Focused SSES and Rehabilitation-Friars Branch 13 (completed)

This project was completed as part of Early Action Capital Improvement Project #3.3.1.13 below (Friars Branch Basin Improvements).

3.2.9 Focused SSES and Rehabilitation-Mackey Branch 5 (completed)

This project was completed as part of Early Action Capital Improvement Project #3.3.1.3 below (East Brainerd Collection System and PS Rehabilitation).

3.2.10 Focused SSES and Rehabilitation-Tennessee River 8 Sewer Improvements

The project involves SSES work in the Tennessee River 8 sewer sub-basin on approximately 96,300 linear feet of pipe to identify areas where unwanted groundwater or stormwater can infiltrate the sanitary sewer system. From the SSES, approximately 38,500 linear feet of sewer and service pipeline and 400 manholes will be repaired or replaced. Approximately 3,700 linear feet of 8 and 10-inch sewer will also be upgraded to 12-inch. The NTP for professional services was issued on January 13, 2021. The construction is anticipated to start in the first half of 2023.

3.2.11 Focused SSES and Rehabilitation-South Chickamauga Creek 9 & Chattanooga Creek 6

The project involves SSES work in the South Chick Creek 9 sewer sub-basin and Chattanooga Creek 6 (sub-basin to be confirmed) on approximately over 74,100 linear feet of pipe to identify areas where groundwater or stormwater can infiltrate the sanitary sewer system. From the SSES, approximately over 29,600 linear feet of sewer and service pipeline and over 190 manholes will be repaired or replaced using methods of cured-in-place pipe, point repairs, and open cut. This project will reduce I/I in both sub-basins and eliminate SSOs, and in particular, the Shallowford Road Chronic SSO located in the South Chick Creek 9 sewer sub-basin. The construction is anticipated to start in the first half of 2023.

3.2.12 Focused SSES and Rehabilitation-Tennessee River 5

The project's rehabilitation works will include cured-in-place pipe ("CIPP"), pipe bursting, open cut construction, point repairs, and manhole rehabilitation and replacement. These upgrades will reduce significant Inflow and Infiltration ("I/I") issues and SSOs in the area, as well as increase the overall system reliability. The NTP for professional services was issued in June 2022. The construction is anticipated to start in the first half of 2023.

3.3 Early Action Capital Improvement Projects (§22)

3.3.1 SSO and Wet Weather Volume Reduction Projects

3.3.1.1 DuPont Pump Station and Basin Improvements – Phase 1 (completed) and Phase 2

The DuPont Pump Station ("PS") and Basin Improvements Phase 1 and 2 projects are being performed pursuant to Paragraph 22 and Appendix C of the CD.

Phase 1 This work has been completed. See Semi-Annual Work Progress Report No. 10 submitted July 30, 2018.

Phase 2 The original plan called for the design and construction of approximately 7.5 million gallons of wet weather storage and a new wet weather PS at the DuPont PS site. Prior to the start of construction in the first half of 2017, public concern of the nature of the project grew and the City undertook an analysis of potential alternatives. In 2018, the City developed a new plan which calls for the re-design and construction of an approximately 22 Million Gallons per Day ("MGD") new wet weather PS further downstream of the existing DuPont PS site on City owned property in a commercial area where the DuPont-Lupton City interceptors merge. The re-design also includes a new diversion structure, standby generator, and upsizing of approximately 7,000 LF section of gravity interceptors.

We note that on August 23, 2018, the City submitted a Notice of Delay to EPA pursuant to paragraph 57 of the Consent Decree, detailing the following with respect to this project: an explanation and description of the reasons for the delay; the anticipated duration of the delay; all actions taken or to be taken to prevent or minimize the delay; a schedule for implementation of any measures to be taken to prevent or mitigate the delay or the effect of the delay; Chattanooga's rationale for attributing such delay to a force majeure event; and a statement as to whether, in the opinion of Chattanooga, such event may cause or contribute to an endangerment to public health, welfare, or the environment.

Since then, new challenges have caused additional delays: the COVID-19 pandemic and associated supply chain issues, along with delays from permitting agencies (e.g., TVA, USACE, and TDEC). The re-design was completed and approved in October 2019. Successful bids for both PS and pipeline contract were received by February 13, 2020. Several challenges slowed down construction, including the 9-month review of the TVA 26a permit from Jan 2020 to Oct 2020, the required Phase 1 Archaeological Survey completed in the Summer of 2020, the SRF review of ATA package for Contract B (Gravity Sewer), lengthy negotiations with the Riverton Development for easement and drainage issues, coordination with the railroad for boring, and a claim between the consultant and the contractor. The construction is now expected to be completed in the first half of 2023.

3.3.1.2 Collegedale Pump Station Improvements (completed)

This project has been completed. See Semi-Annual Work Progress Report No. 7 submitted January 25, 2017.

3.3.1.3 East Brainerd Collection System and Pump Station Rehabilitation (completed)

Collections System Rehabilitation- This work has been completed. See Semi-Annual Report No. 5 submitted January 27, 2016.

PS Rehabilitation- This work has been completed. See Semi-Annual Work Progress Report No. 10 submitted July 30, 2018.

3.3.1.4 Altamont Sewer Basin and Pump Station Improvements (completed)

This project has been completed. See Semi-Annual Work Progress Report No. 2 submitted July 28, 2014.

3.3.1.5 Pineville Pump Station and Sewer Basin Improvements (completed)

This project has been completed. See Semi-Annual Work Progress Report No. 3 submitted January 27, 2015.

3.3.1.6 Citico Creek Interceptor Rehabilitation (completed)

This project has been completed. See Semi-Annual Work Progress Report No. 2 submitted July 28, 2014.

3.3.1.7 Highland Park Sewer Rehabilitation (completed)

This project has been completed. See Semi-Annual Work Progress Report No. 9 submitted January 29, 2018.

3.3.1.8 Citico CSOTF Pump Station Improvement Study (completed)

This project has been completed. See Semi-Annual Work Progress Report No. 3 submitted January 27, 2015.

3.3.1.9 Tremont Area Sewer Separation Study (completed)

This project has been completed. See Semi-Annual Work Progress Report No. 2 submitted July 28, 2014.

3.3.1.10 Enterprise South Industrial Park (“ESIP”) Pump Station, Force Main and Interceptor Upgrade (completed)

This project has been completed. See Semi-Annual Work Progress Report No. 8 submitted July 26, 2017.

3.3.1.11 Orchard Knob Pump Station Improvements (completed)

This work has been completed. See Semi-Annual Work Progress Report No. 10 submitted July 30, 2018.

3.3.1.12 Friars Branch Pump Station Improvements (completed)

This project has been substantial completed. See Semi-Annual Work Process Report No.12 submitted July 31, 2019.

3.3.1.13 Friars Branch Basin Improvements (completed)

This project has been completed. See Semi-Annual Work Progress Report No. 11 submitted January 29, 2019.

3.3.1.14 Chattanooga Creek Interceptor Rehabilitation (completed)

This project has been completed. See Semi-Annual Work Progress Report No. 6 submitted July 27, 2016.

3.3.1.15 Tannery Flats Interceptor Rehabilitation (completed)

This project has been completed. See Semi-Annual Work Progress Report No. 6 submitted July 27, 2016.

3.3.1.16 East Bank/West Bank ("EB/WB") Flow Monitoring (completed)

This project has been completed. See Semi-Annual Work Progress Report No. 6 submitted July 27, 2016.

3.3.2 MBWWTP Projects (completed)**3.3.2.1 MBWWTP Secondary Clarifier Valve Motor Operator Replacement (completed)**

This project has been completed. See Semi-Annual Work Progress Report No. 8 submitted July 26, 2017.

3.3.2.2 MBWWTP Hydraulic and Pump Improvements (completed)

This project has been completed. See Semi-Annual Work Progress Report No. 8 submitted July 26, 2017.

3.3.2.3 MBWWTP Bar and Fine Screen Replacements (completed)

This project has been completed. See Semi-Annual Work Progress Report No. 8 submitted July 26, 2017.

3.3.2.4 MBWWTP Effluent Disinfection System Upgrade (completed)

This project has been completed. See Semi-Annual Work Progress Report No. 6 submitted July 27, 2016.

3.3.3 CSO Projects (completed)**3.3.3.1 Carter Street CSOTF Sewer Outfall Replacement (completed)**

This project has been completed. See Semi-Annual Work Progress Report No. 6 submitted July 27, 2016.

3.3.3.2 Automation of Valve Operators at CSO Facilities (completed)

This project has been completed. See Semi-Annual Work Progress Report No. 1 submitted January 30, 2014.

3.3.4 Operations Projects (completed)

3.3.4.1 South Chickamauga Pump Station Reliability Improvements (completed)

This project has been completed. See Semi-Annual Work Progress Report No. 1 submitted January 30, 2014.

3.3.4.2 MBWWTP Telemetry and Supervisory Control and Data Acquisition (“SCADA”) Upgrades (Completed)

This project has been completed. See Semi-Annual Work Progress Report No. 9 submitted January 29, 2018.

3.4 East Bank/West Bank Outfall Assessment and Rehabilitation Plan (¶23)

3.4.1 East Bank/West Bank Outfall Assessment and Rehabilitation Plan

Pursuant to Paragraph 23 of the Consent Decree, “in the event that either the East Bank Outfall or the West Bank Outfall experiences an SSO within the first (1st) year **following completion of SSES Phase I and the Early Action Capital Improvement Projects**, Chattanooga shall submit to EPA and TDEC for review and comment within seven (7) Months after such SSO event an East Bank/West Bank Assessment and Rehabilitation Plan to eliminate SSOs from these unpermitted outfalls.” (emphasis added). Here, the Early Action Capital Improvement Projects have not yet been completed, so this requirement from the Consent Decree has not yet been triggered.

3.5 Long Term Control Plan (“LTCP”) Updates (¶24)

3.5.1 LTCP-Additional Operational Plan (“AOP”) for Chattanooga Creek CSO Outfalls (¶24.a) (completed)

This project has been completed. See Semi-Annual Work Progress Report No. 9 submitted January 29, 2018.

3.5.2 LTCP – AOP Implementation (¶24.a) (completed)

This project is a result of the recommendations in the AOP for the Chattanooga Creek CSO Outfalls (Central Avenue CSO and William Street CSO) approved by the EPA on February 1, 2018. This plan will augment Chattanooga’s current CSO control measures with additional long-term controls that will ensure that discharges from these CSO’s comply with State water quality standards, specifically the design and installation of Peracetic Acid (“PAA”) disinfection systems for the CSO outfalls. The NTP for professional services was issued June 11, 2019. This project, the CSOTF Equipment Replacement Program (in section 4.20), and the CSOTF Improvements Phase 1 (in section 4.19) projects were bundled, bid, and are being constructed as one construction contract. The NTP for construction was issued November 2021.

We note that on May 26, 2020, the City submitted a Notice of (Anticipated) Delay to EPA pursuant to paragraph 57 of the Consent Decree, detailing the following with respect to this project: an explanation and description of the reasons for the delay; the anticipated duration of the delay; all

actions taken or to be taken to prevent or minimize the delay; a schedule for implementation of any measures to be taken to prevent or mitigate the delay or the effect of the delay; Chattanooga's rationale for attributing such delay to a force majeure event; and a statement as to whether, in the opinion of Chattanooga, such event may cause or contribute to an endangerment to public health, welfare, or the environment. Anticipated delays were due to the COVID-19 pandemic and associated delays for bench-scale testing, design, permitting, and construction. Chattanooga received EPA's response on December 16, 2020, acknowledging that Chattanooga's letter sufficiently documented that a force majeure event had occurred, noting additional information may be required by EPA.

Chattanooga provided a further update to EPA on June 10, 2022, and noted that the project was expected to be completed in the second half of 2022. Chattanooga received a response from EPA on September 12, 2022, stating the following: "upon completion of the project, you provide a notice of completion with a final accounting of the delay and the amount of delay attributable to the force majeure event. The City's final update should also include a final description of the City's efforts to minimize that delay and an explanation of how specific impacts associated with the COVID-19 pandemic have resulted in the specific delay that the City attributes to the force majeure event."

We note here that the project was completed in the second half of 2022, with an overall delay of 18 months. Peracetic Acid ("PAA") was first injected for disinfection of the wet-weather flow on October 31, 2022 at Central CSOTF and on December 14, 2022 at Williams CSOTF. The City estimates that the 18-month delay was related directly to a force majeure event—because of COVID, there were travel restrictions, County-mandated social distancing that limited access to CSOTF facilities, reduced City, TDEC, general contractor staff availability, lab closures, longer lead times for equipment, and lengthy delays in receiving equipment because of shipping issues. We will also provide a final letter to EPA documenting the force majeure.

3.5.3 LTCP-Post Construction Compliance Monitoring Program (§24.b) (completed)

This project has been completed. See Semi-Annual Work Progress Report No. 3 submitted January 27, 2015.

3.5.4 Maximizing Treatment at MBWWTP (§24.c)

This project includes the development of a feasible alternatives analysis to assess the implementation of any feasible alternatives to prevent the illegal Bypass from any treatment process at the MBWWTP. According to paragraph 24.c. of the Consent Decree, "in the event that a Bypass occurs within the first (1st) year **following completion of SSES Phase I and the Early Action Capital Improvement Projects**, Chattanooga shall submit to EPA and TDEC for review and comment within twelve (12) Months after such Bypass event a Feasible Alternatives Analysis in accordance with Section II.C.7 of the CSO Control Policy." (emphasis added). Here, the Early Action Capital Improvement Projects have not yet been completed, so this requirement from the Consent Decree has not yet been triggered.

3.6 MBWWTP Process Controls Program (§25) (completed)

This project has been completed. See Semi-Annual Work Progress Report No. 3 submitted January 27, 2015.

3.7 Green Infrastructure (“GI”) Program Plan for CSS Basins (§26) (completed)

This project has been completed. See Semi-Annual Work Progress Report No. 5 submitted January 27, 2016.

3.8 Civil Penalty (§28-30) (completed)

Compliance with Section VII of the CD requires the payment of the sum of \$476,400 as a civil penalty. Payment of the civil penalty is to be made as follows:

- Cash Payment – 50% of the civil penalty (\$238,200) is to be paid to the United States by FedWire Electronic Funds Transfer. This payment was made to EPA on May 17, 2013.
- State Project – the remaining 50% of the civil penalty is to be spent on the state project in accordance to Appendix D of the CD.

3.8.1 Cash Payment (completed)

In accordance with Paragraph 29 of the CD, the cash payment of \$238,200 was made to EPA on May 17, 2013.

3.8.2 Highland Park GI Demonstration Project (completed)

This project has been completed. See Semi-Annual Work Progress Report No. 11 submitted January 29, 2019.

3.9 Agawela Drive Stream Restoration – SEP (§31-37) (completed)

This project has been completed. See Semi-Annual Work Progress Report No. 10 submitted July 30, 2018.

3.10 Reporting Requirements (§38-45)

Compliance with Section IX of the CD requires the City to submit the following reports on a calendar schedule:

- Quarterly Reports, including detailed information on Chattanooga’s SSOs, CSO discharges and bypasses at the MBEC;
- Annual Work Progress Reports, including CD deliverable milestones achieved in the last 12 months and projections for activities anticipated to be completed in the following 12 months; and
- Annual Reports, including trends and analyses of the results of the Chattanooga CD programs including CMOM and SSO reduction programs.

To date, the following reports have been submitted to the EPA:

- Quarterly Reports 1 – 37;
- Semi-Annual Work Progress Reports 1 – 13;
- Annual Work Progress Report 14 - 15; and

- Annual Reports 1 - 9.

The following reports will be submitted to the EPA during (or shortly after) the next Reporting Period:

- Quarterly Reports 38 - 41;
- Annual Work Progress Report 16, and
- Annual Report 10.

3.11 Stipulated Penalties (§46-55)

Paragraph 48 of the CD sets forth the nine categories of CD violations or milestones subject to stipulated penalties under the CD. There were no demands for stipulated penalties from EPA during this reporting period.

This page is intended to be blank.

4.0 Additional Work (¶39)

According to paragraph 39(c) of the CD, the City is required to include in this Report “any additional information Chattanooga determines is appropriate to demonstrate that Chattanooga is implementing the remedial actions required under this Consent Decree in an adequate and timely manner.” The purpose of this section is to address this requirement of the CD.

In addition to the work progress achieved in accordance with the CD as described in the previous sections, the City continued to implement remedial and improvement efforts under the existing Capital Improvement Program during the Reporting Period. The work described below is aimed at assessing and improving Chattanooga’s Interceptor Sewer System (“ISS”). While not required by the CD, these projects directly impact Chattanooga’s on-going effort to reduce and eliminate SSOs.

4.1 201 Facility Plan Update (completed)

This project has been completed. See Semi-Annual Work Progress Report No. 7 submitted January 25, 2017.

4.2 Citico Pump Station and CSOTF Upgrades (completed)

This project has been completed. See Semi-Annual Work Progress Report No. 11 submitted January 29, 2019.

4.3 South Chick Pump Station Phase II and Spring Creek Pump Station Upgrades (completed)

This project has been completed. See Annual Work Progress Report No. 14 submitted February 02, 2021.

4.4 Carter Street Sewer Rehabilitation (completed)

This project has been completed. See Semi-Annual Work Progress Report No. 8 submitted July 26, 2017.

4.5 MBWWTP-Control Room Upgrades (completed)

This project has been completed. See Semi-Annual Work Progress Report No.12 submitted July 31, 2019.

4.6 MBWWTP – Detritors Rehabilitation (completed)

This project has been completed. See Semi-Annual Work Progress Report No. 11 submitted January 29, 2019.

4.7 Implementation of CD GI Projects in the CSS (completed)

This project has been completed. See Semi-Annual Work Progress Report No.13 submitted January 31, 2020.

4.8 Friar’s Branch-South Chick Creek 5 Interceptor Rehabilitation (completed)

This project has been completed. See Annual Work Progress Report No. 14 submitted February 02, 2021.

4.9 Citico Pump Station Reliability Improvements (completed)

This project has been completed. See Annual Work Progress Report No. 14 submitted February 02, 2021.

4.10 MBWWTP Secondary Clarifier Upgrades and Additions (completed)

This project has been completed. See Semi-Annual Work Progress Report No.12 submitted July 31, 2019.

4.11 CSOTF Study (completed)

This project has been completed. See Semi-Annual Work Progress Report No. 8 submitted July 26, 2017.

4.12 South Chickamauga Interceptor Improvements – Phase 1 (completed)

This project has been completed. See Annual Work Progress Report No. 14 submitted February 02, 2021.

4.13 Focused SSES and Rehabilitation-South Chickamauga Creek 1 – Phase 2 (completed)

This project has been completed. See Annual Work Progress Report No. 15 submitted February 2, 2022.

4.14 Critical Pump Station Improvements Master Plan (completed)

This study has been completed. See Annual Work Progress Report No. 15 submitted February 2, 2022.

4.15 Lupton Drive Chronic SSO Elimination Project (completed)

This project has been completed. See Annual Work Progress Report No. 15 submitted February 2, 2022.

4.16 Brainerd Golf Course Pump Station Safety Upgrade

This project involves making safety improvements to the East Brainerd Golf Course Pump Station. This work includes the replacement and upgrade of the pump station and force main and relocating it to a manageable area off of the golf course. Additionally, approximately 1,400 linear feet of 8-inch gravity sewer will be installed. The upgrades will allow the station to increase its capacity, performance and reliability and help to reduce sanitary sewer overflows in the area. The NTP for professional services was issued in September 2017 and TDEC approval was received on February 13, 2019. This project was bundled with the PS Improvements – Hixson 2 (section 4.17), the Selected Pump Station Safety Upgrades (section 4.41), and the Central Avenue Sewer Improvements (section 4.44) projects, and will be bid, and constructed as one construction contract. The construction is anticipated to start in the first half of 2023 and be completed in the first half of 2025.

4.17 Pump Station Improvements – Hixson 2

This project involves safety and reliability improvements associated with converting the Hixson PS 2 from a canned station to a submersible station. A few of the main components of the project include upsizing the capacity to 13 MGD and replacing the force main. The upgrades will provide the station with better accessibility and allow the station to increase its capacity, performance and reliability, helping reduce sanitary sewer overflows in the area. The NTP for professional services was issued in January 2020. The final design was completed in August 2021. This project was bundled with the Brainerd Golf Course PS Safety Upgrade (section 4.16), the Selected Pump Station Safety Upgrades (section 4.41), and the Central Avenue Sewer Improvements (section 4.44) projects, and will be bid, and constructed as one construction contract. The construction is anticipated to start in the first half of 2023 and be completed in the first half of 2025.

4.18 Wet Weather Combined Sewer Storage – Phase 1, 2 & 3

This project will construct Phase 1, 2 & 3 of wet weather storage system at the Hamm Rd site, which will store peak wet weather flows, reduce flows to the West Bank Overflow, and meet the future capacity needs of the area. The NTP for professional services was issued in November 2017. The construction began in the first half of 2019 and is anticipated to be completed in the first half of 2023.

4.19 CSOTF Improvements – Phase 1

This project stemmed from the CSO Treatment Facility (“CSOTF”) Optimization Plan, which was a three-phased approach to maximizing the use of storage and treatment in 7 CSOTFs within the City’s sewer system. This project implements the first phase and included upgrades to manual controls and addition of equipment for automation and remote control of the CSOTFs. The NTP for professional services was issued on November 16, 2018. This project, the CSOTF Equipment Replacement Program (in section 4.20), and the LTCP – AOP Implementation (see section 3.5.2) projects were bundled together, bid, and are being constructed as one construction contract. The NTP for professional services was issued in November 2018. The design was completed in the first half of 2021 and the construction is anticipated to be completed in the second half of 2023.

4.20 CSOTF Equipment Replacement Program

This project involves the replacement of the fine screens at both the Central Avenue and Citico CSOTFs. The existing fine screens are reaching the end of their useful service life and need replacement. This project, the CSOTF Improvements Phase 1 (in section 4.19), and the LTCP – AOP Implementation (in section 3.5.2) projects were bundled, bid, and are being constructed as one construction contract. The NTP for professional services was issued in January 2020. The construction started in November 2021 and is anticipated to be completed in the first half of 2023.

4.21 Dobbs Branch Basin Improvements – Phase 1

This project involves the creation of construction documents for the rehabilitation of up to 100,000 LF of 8-inch to 24-inch sanitary sewers in the Dobbs Branch sub-basins 3 and 4. The construction documents will provide for the rehabilitation for certain sewer segments and associated manholes. Pipeline rehabilitation methods will include cured-in-place-pipe (“CIPP”), point repairs, pipe bursting, and/or open cut replacement. The design also includes the rehabilitation of up to 400 manholes within the sewer basin through the installation of a watertight spray-on liner. A smoke testing investigation of the 138,000 LF basin will be performed to identify illicit connections. Tabulated and ranked data will be provided to the City for execution outside the contract. The NTP for professional services was issued in September 2018. The design was completed in October 2019, and the construction is expected to be completed in the first half of 2023.

4.22 Dobbs Branch Basin Improvements – Phase 2

This project involves the creation of construction documents for the rehabilitation of up to 100,000 LF of 8-inch to 24-inch sanitary sewers in the Dobbs Branch sub-basins 5 and 6. The construction will provide for the rehabilitation for certain sewer segments and associated manholes. Pipeline rehabilitation methods will include CIPP, point repairs, pipe bursting, and/or open cut replacement. The design also includes the rehabilitation of up to 400 manholes within the sewer basin through the installation of a watertight spray-on liner. A smoke testing investigation of the 137,000 LF basin will be performed to identify illicit connections. Tabulated and ranked data will be provided to the City for execution outside the contract. The NTP for professional services was issued in November 2018. The design was completed in October 2019, and the construction is expected to be completed in the first half of 2023.

4.23 Wet Weather Storage Phase 4 – South Chickamauga Pump Station

This project will construct 10 MG of wet weather storage near the South Chickamauga PS located off of N. Hawthorne St. The project will store peak wet weather flows, reduce the risk of SSOs, and aid in meeting future capacity requirements. The project will also increase reliability in the event of power or mechanical failures. The NTP for professional services was issued in February 2019. The design was completed in September 2022, and the construction is anticipated to start in the first half of 2023.

4.24 Citico Pump Station Improvements

This project involves capital improvements to the Citico PS, including the following upgrades and improvements: (1) New motor control center (“MCC”), (2) New pumps, motors, and drives, (3) The wet well cleaned and coated, (4) Replace 72-inch slide gate and three open channel slide gates, (5) Additional security, structural and electrical upgrades. These improvements are designed to improve the capacity, performance, and reliability of the station, as well as reduce the risk of SSOs in the area. The NTP for professional services was issued in October of 2019. The design was completed in November 2021, and the construction started in the second half of 2022 and is anticipated to be completed in the first half of 2024.

4.25 Riverview Park/CGCC Chronic SSO Elimination Project

This project involves the rehabilitation or upsizing of sanitary sewer pipe and associated manholes located in the Riverview Park and Chattanooga Golf and Country Club area. The goal is to eliminate SSOs in the area by rehabilitating or replacing the manholes and gravity sewer segments (8-inch to 15-inch diameter) immediately upstream and downstream of this location. The NTP for professional services was issued in November 2019. The bid process was completed in February 2021. Most of the construction has been completed; due to the golf course schedule, the construction was delayed and is expected to be completed in the first half of 2024.

4.26 South Chick Creek 2, 3, & 4 Interceptor Rehab

This project involves the evaluation and rehabilitation of approximately 7,850 LF of gravity interceptor pipeline and 16 associated manholes in the South Chickamauga Creek sub-basins 3 and 4. The pipeline rehabilitation will consist of the 72-inch Friar Branch Interceptor from the first manhole downstream of Friars Branch PS, downstream to the junction box on the 84-inch diameter interceptor. The NTP for professional services was issued in July 2019. Additional to the project, the rehabilitation includes 27 manholes and the junction chamber structure, and repair aging sewer infrastructure. The new NTP for professional services was issued in January 2019. The design was completed in October 2021. The construction started in the first half of 2022 and is anticipated to be completed in the first half of 2024.

4.27 Tiftonia Pump Station 1 Safety Upgrade

This project involves safety and reliability improvements associated with converting Tiftonia PS 1 from a “canned” station to a submersible station. The upgrades will provide the station with better

accessibility and allow the station to increase its capacity, performance and reliability, helping reduce SSOs in the area. This project is anticipated to resume in the first half of 2023 based on the results of the Lookout Creek Sewer Basin Master Plan which was completed in November 2022.

4.28 ISS Capacity Improvements – Creekside Preserve

This project includes a SSES on approximately 700 linear feet of pipe to identify areas where unwanted groundwater or stormwater can infiltrate the sanitary sewer system. The evaluation recommends the design and construction of a new submersible grinder PS. The project will help reduce the potential for sanitary sewer overflows in the area, as well as restore collection system capacity and reliability. The NTP for professional services was issued in January 2020, and the design was completed in the second half of 2022. This project was bundled with the Tiftonia Pump Station 2 Safety Upgrade (section 4.31) and the Big Ridge #5 Pump Station Improvements (section 4.36) projects, and will be bid, and constructed as one construction contract. The construction is anticipated to start in the first half of 2023 and be completed in the first half of 2025.

4.29 Wet Weather Storage Phase 6 – Hixson Pump Station 1

This project will construct 5 MG of wet weather storage near the Hixson 1 PS and will store peak wet weather flows to meet the future capacity requirements. The NTP for professional services was issued in December 2019, and the design is estimated to be completed in the first half of 2023. The construction is anticipated to start in the first half of 2023.

4.30 Environmental and Economic Infrastructure Improvement Plan (“E2I2”) SSO Abatement Program

This project involves the planning, engineering, and construction of the equalization (“EQ”) stations to determine the size, location, and required infrastructure improvements needed to construct approximately 47 MG of EQ stations or wet weather storage in three locations within the surrounding area of the City of Chattanooga and Hamilton County, TN. The current locations include Red Bank, East Ridge, and the South Lee Highway area.

E2I2 SSO Abatement Program – East Ridge (West Chickamauga)

This project includes an EQ station with up to 30 MG of capacity near the intersection of I-75 and the South Chickamauga Creek. The EQ Station will include a PS, force main, and gravity sewer improvements.

E2I2 SSO Abatement Program – South Lee Hwy

This project includes an EQ station with up to 7 MG for wet weather storage in the Lee Highway area. This project will include the construction of a PS, force main, gravity sewer line improvements, and infrastructure improvements needed to allow for regional connections to deliver approximately 7 MGD of flow through this location.

E2I2 SSO Abatement Program – Red Bank (Pineville)

This project may include an EQ station with up to 10 MG of capacity near the intersection of Pineville Rd and Hudson Rd. If it is required, the EQ Station will include a PS, force main, and gravity sewer improvements. This project at this location is currently on-hold due to an on-going post rehabilitation study by Hamilton County Water and Wastewater Treatment Authority (“WWTA”) for the Red Bank sewer system.

The NTP for professional services was issued in April 2020, and the 15% design was completed in the second half of 2022. An RFP was issued in November 2022 to select a Design-Build team. Proposals will be received on January 25, 2023. The construction is anticipated to start in the first half of 2024. We note that the e2i2 agreement with the WWTA is in the process of being extended by both WWTA and Chattanooga.

4.31 Tiftonia Pump Station 2 Safety Upgrade

This project includes safety and reliability improvements associated with converting the Tiftonia 2 PS from a “canned” PS to a submersible PS as well as the assessment of the sewer force main for rehabilitation or replacement. The design was completed in June of 2022. This project was bundled with the ISS Capacity Improvements – Creekside Preserve (section 4.28) and the Big Ridge #5 Pump Station Improvements (section 4.36) projects, and will be bid, and constructed as one construction contract. The construction is anticipated to start in the first half of 2023 and be completed in the first half of 2025.

4.32 MBWWTP SCADA Master Plan – Phase 1 - 3

This project involves the development of the initial phase of a comprehensive SCADA System 5-year Master Plan for the City of Chattanooga Waste Resources Division. The Engineer will prepare a report which compiles all findings, analyses, SOP's, and other recommendations to provide SCADA and Operational Technology planning for the City's wastewater and collections systems. The NTP for professional services was issued in December 2019. Phases 1 and 2 of the project have been completed. This project is currently on-hold to allow the City to select their preferred sets of standards for implementation in Phase 3.

4.33 MBWWTP Improvements – Centrifuge Upgrades

This project includes upgrades and improvements which involves the preliminary design for the installation of one existing, pre-purchased centrifuge which is located between Centrifuge Building 1 & 2 at the MBWWTP. The NTP for professional services was issued in June 2020. The design was complete in March 2022 and the construction started in June 2022. This project is currently on-hold.

4.34 Citico Force Main Rehabilitation

This project includes construction scope to replace the 30” force main exiting the Citico PS, located on the south side of the Tennessee River near Citico Creek along Riverside Drive. The force main is approximately 2,000 linear feet spanning the Tennessee River to discharge into a manhole on the north side of the river located on Constitution Drive. Design rehabilitation or replacement will be dependent upon inspection and evaluation of alternatives. The project was

advertised in April 2022 and design (rehabilitation) was completed in March 2022. The project is currently on-hold as the City is considering a new design for replacement.

4.35 Mountain Creek Pump Station Improvements (completed)

This project involved making improvements to the Mountain Creek Pump Station which included the replacement of the Motor Control Center (“MCC”) and the upgrade of the controls at the current facility. The upgrades allowed the station to increase its performance and reliability and helped to reduce the sanitary sewer overflows in the area. The preliminary engineering phase determined the approach utilized for detailed design and construction. The NTP for professional services was issued in May 2020. The design was completed in January 2021 and the construction was completed in April 2022.

4.36 Big Ridge #5 Pump Station Improvements

This project includes improvements to the Big Ridge (“BR”) #5 PS. The improvements include a brand new PS. The NTP for professional services was issued in March 2021. The design is expected to be completed in the first half of 2023. This project was bundled with the ISS Capacity Improvements – Creekside Preserve (section 4.28) and the Tiftonia Pump Station 2 Safety Upgrade (section 4.31) projects, and will be bid, and constructed as one construction contract. The construction is anticipated to start in the first half of 2023 and be completed in the first half of 2025.

4.37 Big Ridge #2 Pump Station Improvements

This project includes improvements to the Big Ridge#2 PS. The control panels show signs of H₂S corrosion and are an early candidate for replacement. After replacement, consideration should be given to relocating the electrical equipment rack and canopy as the rack is too close to the wet well, which is non-compliant with NFPA 820. Other upgrades include the installation of bypass pump connection on force main, new pumps, VFDs and discharge piping, the repair of spalled concrete at effluent pipe penetration in wet well and improving the support for PVC conduit hanging into wet well. These upgrades will increase the system reliability and contribute to reduce SSO in the area. The NTP for professional services was issued in January 2022. The design is expected to be completed in the first half of 2023, and the construction is anticipated to be completed in the second half of 2023.

4.38 Highland Park Pump Station Improvements

This project includes improvements to the Highland Park wet weather PS. The PS is in bad condition. These include the full rehabilitation of the PS, replacement of pumps with VFDs, replacement of all electrical and MCC, new discharge piping, new safety grating, and wet well lining. These upgrades will increase the system reliability and contribute to reduce SSO in the area. The NTP for professional services was issued in January 2022. The design is expected to be completed in the first half of 2023, and the construction is anticipated to start in the second half of 2023.

4.39 Lookout Creek Sewer Basin Master Plan (completed)

This project included the development of a sewer Master Plan that evaluated the condition, and existing and future capacity of the sewer system in the Lookout Creek basin which identified a strategic, prioritized capital improvement approach. This basin will experience significant growth, and the Master Plan was the basis for infrastructure upgrades such as the Tiftonia Pump Stations. The NTP for professional services was issued in April 2021. The Master Plan was completed in November 2022.

4.40 MBWWTP Wet Weather Response Team (completed)

This project evaluated the effect of wet weather events on the various City sewers, combined sewer overflow treatment facilities (“CSOTF”), PSs, and Moccasin Bend Environmental Campus (“MBEC”) to improve operation efficiency and reduce SSOs. The project included monitoring and observation of wet weather events at the MBEC, an update of the wet weather operation SOP, and training of, real-time assistance, to operators during wet weather events to avoid West Bank overflows. The NTP for professional services was issued in October 2018 and the study and development and implementation of new SOPs were substantially completed in September 2022.

4.41 Selected Pump Station Safety Upgrades

This project will evaluate, design and construct new (replacement) wastewater pumping stations located at Murray Hills #5, off Webb Road and Brainerd Manor located off Moore Road, near the airport. The existing stations are “can” stations and in need of new standard pump stations utilizing the existing design criteria regarding flow data, pump requirements, wet well size, etc. per respective station. The NTP for professional services was issued in July 2018. The design was completed in the first half of 2022. This project was bundled with the Brainerd Golf Course PS Safety Upgrade (section 4.16), the Pump Station Improvements – Hixson 2 (section 4.17), and the Central Avenue Sewer Improvements (section 4.44) projects, and will be bid, and constructed as one construction contract. The construction is anticipated to start in the first half of 2023 and be completed in the first half of 2025.

4.42 23rd Street Pump Station Improvements

This project includes making capital improvements to the 23rd Street PS within the screening room, dry well, wet well, electrical room, and the site, in general. These improvements are designed to improve the capacity, performance and reliability of the station and help to reduce sanitary sewer overflows in the area. The NTP for professional services was issued in March 2021. The design was completed in August 2022, and the construction is anticipated to start in the second half of 2023.

4.43 Influent Pump Station Improvements (IPS Screen Bypass)

This project includes the addition of a bypass system to allow for flow through the Influent Pump Station (IPS) and to the MBEC process during blinding conditions of the IPS screen, as well as the replacement of the bar screens. The NTP for professional services was issued in May 2021.

The design began in the second half of 2022, and the construction is anticipated to start in the second half of 2023.

4.44 Central Avenue Sewer Improvements (Prev. Lupton City Sewer Rehab)

The purpose of this project is to abandon a damaged 18" sewer line between manholes S167C067 and S167C068 that crosses the Southern Cellulose facility at Central Avenue and East 42nd Street. Two alternatives that were considered included relocation of the existing sewer around the Southern Cellulose facility, and a small pump station to send flows from manhole S167C067 to manhole S167C073. The small pump station was the chosen alternative. The NTP for professional services was issued in June 2020. The design was completed in September 2022. This project was bundled with the Brainerd Golf Course PS Safety Upgrade (section 4.16), the PS Improvements – Hixson 2 (section 4.17), and the Selected Pump Station Safety Upgrades (section 4.41) projects, and will be bid, and constructed as one construction contract. The construction is anticipated to start in the first half of 2023 and be completed in the first half of 2025.

4.45 Winterview Pump Station and Basin Improvements

This project includes upgrades to the Winterview Pump Station. The Pump Station is currently equipped with a temporary pump and controls and needs to be improved to include permanent, reliable equipment. This project will increase reliability in the system and contribute to reduce SSO. The NTP for professional services was issued in January 2022. The design began in December 2022, and the construction is anticipated to start in the first half of 2023.

4.46 Tiftonia Pump Station #3 Improvements

This project involves improvements to the Tiftonia #3 Pump Station. The project will include a replacement pump station with submersible pumps, potential capacity upgrade, control panel with associated electrical, SCADA, wet well, and valving. The existing station will be demolished, and the existing gravity flow will be routed to the new station. These upgrades will increase the system reliability and contribute to reduce SSOs in the area. The NTP for professional services was issued in October 2022. The design is estimated to begin in the first half of 2023 and be completed in the second half of 2023.

4.47 South Chickamauga Pump Station Improvements

This project involves improvements to the South Chick Creek Pump Station due to its aging condition and critical rank on the City's Pump Station Master Plan. Some of the main components this project will include are new pumps, motors, controls, electrical, SCADA, rake bar, sluice gates, air scrubber, and HVAC. These upgrades will increase the system reliability and contribute to reduce SSO in the area. The NTP for professional services was issued in November 2022. The planning started in November 2022 and construction is expected to start in the first half of 2024.

4.48 Green Infrastructure – Lincoln Park

This project includes improvements to water quality control measures for roadways and landscaping, such as bioswales, green pavers, vegetation, a “green” or living wall as a noise barrier for the railyard. These upgrades will contribute to reduce SSOs in the area. The project is currently being redesigned as poor soil was encountered during field investigations. The construction is not anticipated to start until the second half of 2023.

This page is intended to be blank.

Appendix A

Project Schedules Gantt Chart

Activity ID	Activity Name	At Completion Duration	Start	Finish	2013		2014				2015				2016				2017				2018				2019				2020				2021				2022				2023				2024				2025				2026			
					Q1	Q2	Q3	Q4	Q1	Q2	Q3	Q4	Q1	Q2	Q3	Q4	Q1	Q2	Q3	Q4	Q1	Q2	Q3	Q4	Q1	Q2	Q3	Q4	Q1	Q2	Q3	Q4	Q1	Q2	Q3	Q4	Q1	Q2	Q3	Q4	Q1	Q2	Q3	Q4	Q1	Q2	Q3	Q4										
Chattanooga Consent Decree Deliverables Schedule																																																										
Program Milestones																																																										
Program Milestones																																																										
Consent Decree Effective Date																																																										
PROGRAM MILESTONES																																																										
OO1000	Consent Decree Effective Date	0	24-Apr-13 A	24-Apr-13 A																																																						
Section VI - Compliance Requirements																																																										
Para 20 - CMOM																																																										
CMOM-Sewer Overflow Response Protocol (SORP)																																																										
Consent Decree Duration (7 Months)																																																										
OA0100	Consent Decree Duration (7 Months)	215	24-Apr-13 A	25-Nov-13 A																																																						
OA0110	Consent Decree Duration Completion Milestone	0		25-Nov-13 A																																																						
Project Procurement																																																										
OA0200	PM Procurement	0	15-Jul-12 A	15-Jul-12 A																																																						
Planning Phase																																																										
OA0010	Administration Period	229	15-Jul-12 A	28-Feb-13 A																																																						
OA1000	Planning Phase	235	01-Mar-13 A	22-Oct-13 A																																																						
Public Document Repository																																																										
OA2000	Submit Draft Deliverable to Reference Librarian	0	23-Oct-13 A	23-Oct-13 A																																																						
OA2010	Post Copy of Draft Deliverable on City's Website	0	23-Oct-13 A	23-Oct-13 A																																																						
OA2020	Public Review Period	31	24-Oct-13 A	24-Nov-13 A																																																						
OA2030	Public Comment Review Period	2	23-Nov-13 A	25-Nov-13 A																																																						
OA2040	Submit Deliverable to EPA, TDEC and Provide notice to TCWN	0		25-Nov-13 A																																																						
EPA and TDEC Approvals																																																										
OA0900	Place Copy of EPA and TDEC Submittal in PDR	8	26-Nov-13 A	04-Dec-13 A																																																						
OA0910	EPA / TDEC Review	183	26-Nov-13 A	28-May-14 A																																																						
OA0920	Address Comments for Final EPA / TDEC Approval	62	29-Mar-14 A	29-May-14 A																																																						
OA0930	Submit Copy of Approved Deliverable in the PDR (within 7 days following Receipt of Approval by EPA)	7	30-May-14 A	05-Jun-14 A																																																						
CMOM-Emergency Response Plan																																																										
Consent Decree Duration (19 Months)																																																										
OB0100	Consent Decree Duration (19 Months)	580	24-Apr-13 A	24-Nov-14 A																																																						
OB0110	Consent Decree Duration Completion Milestone	0		24-Nov-14 A																																																						
Project Procurement																																																										
OB1000	CD Prequalification Procurement (FY 2012 - 2013) Priority I - Development and Issuance of RFP	45	18-Oct-12 A	01-Dec-12 A																																																						
OB1010	Consultant develops and Submit Scope and Cost proposal	10	18-Oct-12 A	27-Oct-12 A																																																						
OB1020	PMO Reviews/ Negotiates and Approve Proposal / Agreement	10	18-Oct-12 A	27-Oct-12 A																																																						
OB1030	PMO Approved Agreement to Council for Approval	18	18-Oct-12 A	04-Nov-12 A																																																						
OB1040	Consultant Signed Agreement to City for Execution	14	18-Oct-12 A	31-Oct-12 A																																																						
Planning Phase																																																										
OB2000	Planning Phase	575	23-Jan-13 A	20-Aug-14 A																																																						

Summary
 Actual Work
 Remaining Work
 Critical Remaining Work
 Baseline Milestone

CHATTANOOGA CONSENT DECREE PROGRAM - PHASE I-2
CITY OF CHATTANOOGA, TN
WASTEWATER DEPARTMENT

Activity ID	Activity Name	At Completion Duration	Start	Finish	2013				2014				2015				2016				2017				2018				2019				2020				2021				2022				2023				2024				2025				2026			
					Q1	Q2	Q3	Q4	Q1	Q2	Q3	Q4	Q1	Q2	Q3	Q4	Q1	Q2	Q3	Q4	Q1	Q2	Q3	Q4	Q1	Q2	Q3	Q4	Q1	Q2	Q3	Q4	Q1	Q2	Q3	Q4	Q1	Q2	Q3	Q4	Q1	Q2	Q3	Q4	Q1	Q2	Q3	Q4	Q1	Q2	Q3	Q4								
OD1000	CD Prequalification Procurement (FY 2012 - 2013) Priority I - Development and Issuance of RFP	45	18-Oct-12 A	01-Dec-12 A	Prequalification Procurement (FY 2012 - 2013) Priority I - Development and Issuance of RFP																																																							
OD1130	Consultant develops and Submit Scope and Cost proposal	10	02-Dec-12 A	11-Dec-12 A	Consultant develops and Submit Scope and Cost proposal																																																							
OD1140	PMO Reviews/ Negotiates and Approve Proposal / Agreement	10	12-Dec-12 A	21-Dec-12 A	PMO Reviews/ Negotiates and Approve Proposal / Agreement																																																							
OD1150	PMO Approved Agreement to Council for Approval	18	22-Dec-12 A	08-Jan-13 A	PMO Approved Agreement to Council for Approval																																																							
OD1160	Consultant Signed Agreement to City for Execution	14	09-Jan-13 A	22-Jan-13 A	Consultant Signed Agreement to City for Execution																																																							
Planning Phase		448	23-Jan-13 A	16-Apr-14 A	Planning Phase																																																							
OD1010	Planning Phase	429	23-Jan-13 A	28-Mar-14 A	Planning Phase																																																							
OD1170	Program Manager / Owner Review and Coordination	18	29-Mar-14 A	16-Apr-14 A	Program Manager / Owner Review and Coordination																																																							
Public Document Repository		34	17-Apr-14 A	21-May-14 A	Public Document Repository																																																							
OD1020	Submit Draft Deliverable to Reference Librarian	0	17-Apr-14 A	17-Apr-14 A	Submit Draft Deliverable to Reference Librarian																																																							
OD1030	Post Copy of Draft Deliverable on City's Website	0	17-Apr-14 A	17-Apr-14 A	Post Copy of Draft Deliverable on City's Website																																																							
OD1040	Public Review Period	30	17-Apr-14 A	17-May-14 A	Public Review Period																																																							
OD1050	Public Comment Review Period	3	18-May-14 A	21-May-14 A	Public Comment Review Period																																																							
OD1060	Submit Deliverable to EPA, TDEC and Provide notice to TCWN	0		21-May-14 A	Submit Deliverable to EPA, TDEC and Provide notice to TCWN																																																							
EPA and TDEC Approvals		201	22-May-14 A	09-Dec-14 A	EPA and TDEC Approvals																																																							
OD1070	Place Copy of EPA and TDEC Submittal in PDR	5	22-May-14 A	27-May-14 A	Place Copy of EPA and TDEC Submittal in PDR																																																							
OD1080	EPA / TDEC Review	46	22-May-14 A	07-Jul-14 A	EPA / TDEC Review																																																							
OD1090	Address Comments for Final EPA / TDEC Approval	150	08-Jul-14 A	05-Dec-14 A	Address Comments for Final EPA / TDEC Approval																																																							
OD1100	Submit Copy of Approved Deliverable in the PDR (within 7 days following Receipt of Approval by EPA)	3	06-Dec-14 A	09-Dec-14 A	Submit Copy of Approved Deliverable in the PDR (within 7 days following Receipt of Approval by EPA)																																																							
CMOM-PS Operations and Preventive Maint. Programs		1099	18-Oct-12 A	22-Oct-15 A	CMOM-PS Operations and Preventive Maint. Programs																																																							
Consent Decree Duration (19 Months)		580	24-Apr-13 A	24-Nov-14 A	Consent Decree Duration (19 Months)																																																							
OE1110	Consent Decree Duration	579	24-Apr-13 A	24-Nov-14 A	Consent Decree Duration																																																							
OE1120	Consent Decree Duration Completion Milestone	0		24-Nov-14 A	Consent Decree Duration Completion Milestone																																																							
Project Procurement		97	18-Oct-12 A	22-Jan-13 A	Project Procurement																																																							
OE1000	CD Prequalification Procurement (FY 2012 - 2013) Priority I - Development and Issuance of RFP	45	18-Oct-12 A	01-Dec-12 A	Prequalification Procurement (FY 2012 - 2013) Priority I - Development and Issuance of RFP																																																							
OE3100	Consultant develops and Submit Scope and Cost proposal	10	02-Dec-12 A	11-Dec-12 A	Consultant develops and Submit Scope and Cost proposal																																																							
OE3110	PMO Reviews/ Negotiates and Approve Proposal / Agreement	10	12-Dec-12 A	21-Dec-12 A	PMO Reviews/ Negotiates and Approve Proposal / Agreement																																																							
OE3120	PMO Approved Agreement to Council for Approval	18	22-Dec-12 A	08-Jan-13 A	PMO Approved Agreement to Council for Approval																																																							
OE3130	Consultant Signed Agreement to City for Execution	14	09-Jan-13 A	22-Jan-13 A	Consultant Signed Agreement to City for Execution																																																							
Planning Phase		626	24-Jan-13 A	12-Oct-14 A	Planning Phase																																																							
OE1010	Planning Phase	613	24-Jan-13 A	29-Sep-14 A	Planning Phase																																																							
OE1130	Program Manager / Owner Review and Coordination	12	30-Sep-14 A	12-Oct-14 A	Program Manager / Owner Review and Coordination																																																							
Public Document Repository		36	13-Oct-14 A	18-Nov-14 A	Public Document Repository																																																							
OE1020	Submit Draft Deliverable to Reference Librarian	0	13-Oct-14 A	13-Oct-14 A	Submit Draft Deliverable to Reference Librarian																																																							
OE1040	Public Review Period	35	13-Oct-14 A	17-Nov-14 A	Public Review Period																																																							
OE1030	Post Copy of Draft Deliverable on City's Website	0	13-Oct-14 A	13-Oct-14 A	Post Copy of Draft Deliverable on City's Website																																																							
OE1050	Public Comment Review Period	0	18-Nov-14 A	18-Nov-14 A	Public Comment Review Period																																																							

Summary
 Actual Work
 Remaining Work
 Critical Remaining Work
 Baseline Milestone

CHATTANOOGA CONSENT DECREE PROGRAM - PHASE I-2
CITY OF CHATTANOOGA, TN
WASTEWATER DEPARTMENT

Activity ID	Activity Name	At Completion Duration	Start	Finish	2013												2014												2015												2016												2017												2018												2019												2020												2021												2022												2023												2024												2025												2026											
					Q1	Q2	Q3	Q4	Q1	Q2	Q3	Q4	Q1	Q2	Q3	Q4	Q1	Q2	Q3	Q4	Q1	Q2	Q3	Q4	Q1	Q2	Q3	Q4	Q1	Q2	Q3	Q4	Q1	Q2	Q3	Q4	Q1	Q2	Q3	Q4	Q1	Q2	Q3	Q4	Q1	Q2	Q3	Q4	Q1	Q2	Q3	Q4	Q1	Q2	Q3	Q4	Q1	Q2	Q3	Q4	Q1	Q2	Q3	Q4																																																																																																												
Focused SSES and Rehab - Dobb's Branch 3					Focused SSES and Rehab - Dobb's Branch 3																																																																																																																																																																							
Consent Decree Duration (87 Months)					Consent Decree Duration (87 Months)																																																																																																																																																																							
OK1040	Consent Decree Duration	2651	24-Apr-13 A	27-Jul-20 A	Consent Decree Duration																																																																																																																																																																							
OK1050	Consent Decree Duration Completion Milestone	0		27-Jul-20 A	Consent Decree Duration Completion Milestone																																																																																																																																																																							
Project Procurement					Project Procurement																																																																																																																																																																							
OK1090	CD Prequalification Procurement (FY 2012 - 2013) Priority II - Development and Issuance of RFP	66	12-Dec-12 A	15-Feb-13 A	CD Prequalification Procurement (FY 2012 - 2013) Priority II - Development and Issuance of RFP																																																																																																																																																																							
OK1100	Consultant develops and Submit Scope and Cost proposal	14	16-Feb-13 A	01-Mar-13 A	Consultant develops and Submit Scope and Cost proposal																																																																																																																																																																							
OK1110	PMO Reviews/ Negotiates and Approve Proposal / Agreement	13	02-Mar-13 A	15-Mar-13 A	PMO Reviews/ Negotiates and Approve Proposal / Agreement																																																																																																																																																																							
OK1120	PMO Approved Agreement to Council for Approval	6	16-Mar-13 A	22-Mar-13 A	PMO Approved Agreement to Council for Approval																																																																																																																																																																							
OK1130	Consultant Signed Agreement to City for Execution	26	23-Mar-13 A	18-Apr-13 A	Consultant Signed Agreement to City for Execution																																																																																																																																																																							
Planning Phase					Planning Phase																																																																																																																																																																							
OK1000	Planning Phase	564	19-Apr-13 A	04-Nov-14 A	Planning Phase																																																																																																																																																																							
OK1060	SRF Facility Plan Approval	186	24-Oct-13 A	28-Apr-14 A	SRF Facility Plan Approval																																																																																																																																																																							
Engineering Phase					Engineering Phase																																																																																																																																																																							
OK1010	Engineering	357	05-Nov-14 A	28-Oct-15 A	Engineering																																																																																																																																																																							
OK1020	SRF Approval of Contract Documents	20	08-Oct-15 A	28-Oct-15 A	SRF Approval of Contract Documents																																																																																																																																																																							
Construction Bidding Phase					Construction Bidding Phase																																																																																																																																																																							
OK1070	Construction Bidding Phase	118	29-Oct-15 A	23-Feb-16 A	Construction Bidding Phase																																																																																																																																																																							
OK2000	SRF Administration Period	20	24-Feb-16 A	14-Mar-16 A	SRF Administration Period																																																																																																																																																																							
Construction Phase					Construction Phase																																																																																																																																																																							
OK1080	Construction Phase	897	15-Feb-16 A	31-Jul-18 A	Construction Phase																																																																																																																																																																							
EPA and TDEC Approvals					EPA and TDEC Approvals																																																																																																																																																																							
OK1030	Notification of Completion to EPA, TDEC, TCWN	0	31-Jul-18 A	31-Jul-18 A	Notification of Completion to EPA, TDEC, TCWN																																																																																																																																																																							
Focused SSES and Rehab - South Chick Creek 1					Focused SSES and Rehab - South Chick Creek 1																																																																																																																																																																							
Consent Decree Duration (87 Months)					Consent Decree Duration (87 Months)																																																																																																																																																																							
OL1040	Consent Decree Duration	2651	24-Apr-13 A	27-Jul-20 A	Consent Decree Duration																																																																																																																																																																							
OL1050	Consent Decree Duration Completion Milestone	0		27-Jul-20 A	Consent Decree Duration Completion Milestone																																																																																																																																																																							
Project Procurement					Project Procurement																																																																																																																																																																							
OL1090	CD Prequalification Procurement (FY 2012 - 2013) Priority II - Development and Issuance of RFP	66	12-Dec-12 A	15-Feb-13 A	CD Prequalification Procurement (FY 2012 - 2013) Priority II - Development and Issuance of RFP																																																																																																																																																																							
OL1100	Consultant develops and Submit Scope and Cost proposal	14	16-Feb-13 A	01-Mar-13 A	Consultant develops and Submit Scope and Cost proposal																																																																																																																																																																							
OL1110	PMO Reviews/ Negotiates and Approve Proposal / Agreement	14	02-Mar-13 A	15-Mar-13 A	PMO Reviews/ Negotiates and Approve Proposal / Agreement																																																																																																																																																																							
OL1120	PMO Approved Agreement to Council for Approval	7	16-Mar-13 A	22-Mar-13 A	PMO Approved Agreement to Council for Approval																																																																																																																																																																							
OL1130	Consultant Signed Agreement to City for Execution	27	23-Mar-13 A	18-Apr-13 A	Consultant Signed Agreement to City for Execution																																																																																																																																																																							
Planning Phase					Planning Phase																																																																																																																																																																							
OL1000	Planning Phase	828	26-Jun-13 A	01-Oct-15 A	Planning Phase																																																																																																																																																																							
Engineering Phase					Engineering Phase																																																																																																																																																																							
OL1010	Engineering	665	11-Feb-15 A	07-Dec-16 A	Engineering																																																																																																																																																																							
OL1020	SRF Approval of Contract Documents	175	08-Dec-16 A	01-Jun-17 A	SRF Approval of Contract Documents																																																																																																																																																																							
Construction Bidding Phase					Construction Bidding Phase																																																																																																																																																																							
		190	29-Dec-16 A	07-Jul-17 A	Construction Bidding Phase																																																																																																																																																																							

- Summary
- Actual Work
- Remaining Work
- Critical Remaining Work
- Baseline Milestone

**CHATTANOOGA CONSENT DECREE PROGRAM - PHASE I-2
CITY OF CHATTANOOGA, TN
WASTEWATER DEPARTMENT**

Activity ID	Activity Name	At Completion Duration	Start	Finish	2013				2014				2015				2016				2017				2018				2019				2020				2021				2022				2023				2024				2025				2026																										
					Q1	Q2	Q3	Q4	Q1	Q2	Q3	Q4	Q1	Q2	Q3	Q4	Q1	Q2	Q3	Q4	Q1	Q2	Q3	Q4	Q1	Q2	Q3	Q4	Q1	Q2	Q3	Q4	Q1	Q2	Q3	Q4	Q1	Q2	Q3	Q4	Q1	Q2	Q3	Q4	Q1	Q2	Q3	Q4																																			
OL1070	Construction Bidding Phase	181	29-Dec-16 A	28-Jun-17 A																Construction Bidding Phase																																																															
OL1075	SRF Administration Period	8	29-Jun-17 A	07-Jul-17 A																SRF Administration Period																																																															
Construction Phase		384	07-Jul-17 A	26-Jul-18 A																Construction Phase																																																															
OL1080	Construction Phase	384	07-Jul-17 A	26-Jul-18 A																Construction Phase																																																															
EPA and TDEC Approvals		0	31-Jul-20 A	31-Jul-20 A																																																																															
OL1030	Notification of Completion to EPA, TDEC, TCWN	0	31-Jul-20 A	31-Jul-20 A																																																																															
Focused SSES and Rehab - South Chick Creek 5		2788	12-Dec-12 A	31-Jul-20 A	Focused SSES and Rehab - South Chick Creek 5																																																																														
Consent Decree Duration (87 Months)		2651	24-Apr-13 A	27-Jul-20 A	Consent Decree Duration (87 Months)																																																																														
OM1040	Consent Decree Duration	2651	24-Apr-13 A	27-Jul-20 A	Consent Decree Duration																																																																														
OM1050	Consent Decree Duration Completion Milestone	0		27-Jul-20 A																																																																															
Project Procurement		128	12-Dec-12 A	18-Apr-13 A	Project Procurement																																																																														
OM1090	CD Prequalification Procurement (FY 2012 - 2013) Priority II - Development and Issuance of RFP	66	12-Dec-12 A	15-Feb-13 A	CD Prequalification Procurement (FY 2012 - 2013) Priority II - Development and Issuance of RFP																																																																														
OM1100	Consultant develops and Submit Scope and Cost proposal	14	16-Feb-13 A	01-Mar-13 A	Consultant develops and Submit Scope and Cost proposal																																																																														
OM1110	PMO Reviews/ Negotiates and Approve Proposal / Agreement	14	02-Mar-13 A	15-Mar-13 A	PMO Reviews/ Negotiates and Approve Proposal / Agreement																																																																														
OM1120	PMO Approved Agreement to Council for Approval	7	16-Mar-13 A	22-Mar-13 A	PMO Approved Agreement to Council for Approval																																																																														
OM1130	Consultant Signed Agreement to City for Execution	27	23-Mar-13 A	18-Apr-13 A	Consultant Signed Agreement to City for Execution																																																																														
Planning Phase		620	03-Jun-13 A	13-Feb-15 A	Planning Phase																																																																														
OM1000	Planning Phase	620	03-Jun-13 A	13-Feb-15 A	Planning Phase																																																																														
OM1060	SRF Facility Plan Approval	186	24-Oct-13 A	28-Apr-14 A	SRF Facility Plan Approval																																																																														
Engineering Phase		728	13-Feb-15 A	10-Feb-17 A	Engineering Phase																																																																														
OM1010	Engineering	642	13-Feb-15 A	16-Nov-16 A	Engineering																																																																														
OM1020	SRF Approval of Contract Documents	94	08-Nov-16 A	10-Feb-17 A	SRF Approval of Contract Documents																																																																														
Construction Bidding Phase		141	08-Nov-16 A	29-Mar-17 A	Construction Bidding Phase															Construction Bidding Phase																																																															
OM1070	Construction Bidding Phase	127	08-Nov-16 A	15-Mar-17 A	Construction Bidding Phase															Construction Bidding Phase																																																															
OM1075	SRF Administration Period	13	16-Mar-17 A	29-Mar-17 A	SRF Administration Period																																																																														
Construction Phase		519	26-Apr-17 A	27-Sep-18 A	Construction Phase															Construction Phase																																																															
OM1080	Construction Phase	519	26-Apr-17 A	27-Sep-18 A	Construction Phase															Construction Phase																																																															
EPA and TDEC Approvals		0	31-Jul-20 A	31-Jul-20 A																																																																															
OM1030	Notification of Completion to EPA, TDEC, TCWN	0	31-Jul-20 A	31-Jul-20 A																																																																															
Focused SSES and Rehab - South Chick Creek 16		3412	25-Mar-11 A	27-Jul-20 A	South Chick Creek 16																																																																														
Consent Decree Duration (87 Months)		2651	24-Apr-13 A	27-Jul-20 A	Consent Decree Duration (87 Months)																																																																														
ON1040	Consent Decree Duration	2651	24-Apr-13 A	27-Jul-20 A	Consent Decree Duration																																																																														
ON1050	Consent Decree Duration Completion Milestone	0		27-Jul-20 A																																																																															
Project Procurement		1	07-Sep-12 A	07-Sep-12 A	Previously Procured Consent Decree Projects																																																																														
ON1090	Previously Procured Consent Decree Projects	1	07-Sep-12 A	07-Sep-12 A	Previously Procured Consent Decree Projects																																																																														
Planning Phase		797	25-Mar-11 A	30-May-13 A	Planning Phase																																																																														
ON1000	Planning Phase	797	25-Mar-11 A	30-May-13 A	Planning Phase																																																																														
ON1060	SRF Facility Plan Approval	201	07-Sep-12 A	26-Mar-13 A	SRF Facility Plan Approval																																																																														
Engineering Phase		497	27-Mar-12 A	06-Aug-13 A	Engineering Phase																																																																														
ON1010	Engineering	368	27-Mar-12 A	29-Mar-13 A	Engineering																																																																														



CHATTANOOGA CONSENT DECREE PROGRAM - PHASE I-2
CITY OF CHATTANOOGA, TN
WASTEWATER DEPARTMENT

Activity ID	Activity Name	At Completion Duration	Start	Finish	2013				2014				2015				2016				2017				2018				2019				2020				2021				2022				2023				2024				2025				2026			
					Q1	Q2	Q3	Q4	Q1	Q2	Q3	Q4	Q1	Q2	Q3	Q4	Q1	Q2	Q3	Q4	Q1	Q2	Q3	Q4	Q1	Q2	Q3	Q4	Q1	Q2	Q3	Q4	Q1	Q2	Q3	Q4	Q1	Q2	Q3	Q4	Q1	Q2	Q3	Q4	Q1	Q2	Q3	Q4	Q1	Q2	Q3	Q4								
ON1020	SRF Approval of Contract Documents	129	30-Mar-13 A	06-Aug-13 A	SRF Approval of Contract Documents																																																							
Construction Bidding Phase		207	07-Aug-13 A	02-Mar-14 A	Construction Bidding Phase																																																							
ON1070	Construction Bidding Phase	132	07-Aug-13 A	17-Dec-13 A	Construction Bidding Phase																																																							
ON1075	SRF Administration Period	74	18-Dec-13 A	02-Mar-14 A	SRF Administration Period																																																							
Construction Phase		652	03-Mar-14 A	15-Dec-15 A	Construction Phase																																																							
ON1080	Construction Phase	652	03-Mar-14 A	15-Dec-15 A	Construction Phase																																																							
EPA and TDEC Approvals		15	30-Nov-15 A	15-Dec-15 A	EPA and TDEC Approvals																																																							
ON1030	Notification of Completion to EPA, TDEC, TCWN	15	30-Nov-15 A	15-Dec-15 A	Notification of Completion to EPA, TDEC, TCWN																																																							
Implement SSES Phase II Program		1857	30-Jun-16 A	31-Jul-21 A	Implement SSES Phase II Program																																																							
A1000	Implement SSES Phase II Program	1857	30-Jun-16 A	31-Jul-21 A	Implement SSES Phase II Program																																																							
Focused SSES & Rehab - TN River 8		1657	01-Oct-20 A	14-Apr-25	Focused SSES & Rehab - TN River 8																																																							
Project Procurement		104	01-Oct-20 A	13-Jan-21 A	Project Procurement																																																							
A11880	Procurement Phase	104	01-Oct-20 A	13-Jan-21 A	Procurement Phase																																																							
Planning Phase		229	13-Jan-21 A	30-Aug-21 A	Planning Phase																																																							
A11890	Planning Phase	229	13-Jan-21 A	30-Aug-21 A	Planning Phase																																																							
Engineering Phase		225	30-Aug-21 A	12-Apr-22 A	Engineering Phase																																																							
A11900	Engineering Phase	225	30-Aug-21 A	12-Apr-22 A	Engineering Phase																																																							
Construction Bidding Phase		272	13-Apr-22 A	09-Jan-23	Construction Bidding Phase																																																							
A11910	Construction Bidding Phase	272	13-Apr-22 A	09-Jan-23	Construction Bidding Phase																																																							
Construction Phase		766	10-Jan-23	13-Feb-25	Construction Phase																																																							
A11920	Construction Phase	766	10-Jan-23	13-Feb-25	Construction Phase																																																							
Project Closeout		60	14-Feb-25	14-Apr-25	Project Closeout																																																							
A12810	Project Closeout	60	14-Feb-25	14-Apr-25	Project Closeout																																																							
Focused SSES & Rehab - South Chick Crk 9		929	31-Jan-22 A	16-Aug-24	Focused SSES & Rehab - South Chick Crk 9																																																							
Planning Phase		414	31-Jan-22 A	20-Mar-23	Planning Phase																																																							
A11180	Planning Phase	414	31-Jan-22 A	20-Mar-23	Planning Phase																																																							
Engineering Phase		90	21-Mar-23	18-Jun-23	Engineering Phase																																																							
A11270	Engineering Phase	90	21-Mar-23*	18-Jun-23	Engineering Phase																																																							
Construction Phase		365	19-Jun-23	17-Jun-24	Construction Phase																																																							
A11290	Construction Phase	365	19-Jun-23*	17-Jun-24	Construction Phase																																																							
Project Closeout		60	18-Jun-24	16-Aug-24	Project Closeout																																																							
A12910	Project Closeout	60	18-Jun-24	16-Aug-24	Project Closeout																																																							
Focused SSES & Rehab - Phase 2 (FY23) Tennessee River 5		759	30-Jun-22 A	27-Jul-24	Focused SSES & Rehab - Phase 2 (FY23) Tennessee River 5																																																							
Planning Phase		244	30-Jun-22 A	28-Feb-23	Planning Phase																																																							
A11190	Planning Phase	244	30-Jun-22 A	28-Feb-23	Planning Phase																																																							
Engineering Phase		90	01-Mar-23	29-May-23	Engineering Phase																																																							
A11300	Engineering Phase	90	01-Mar-23	29-May-23	Engineering Phase																																																							
Construction Phase		365	30-May-23	28-May-24	Construction Phase																																																							
A11320	Construction Phase	365	30-May-23	28-May-24	Construction Phase																																																							
Project Closeout		60	29-May-24	27-Jul-24	Project Closeout																																																							
A11630	Project Closeout	60	29-May-24	27-Jul-24	Project Closeout																																																							
Para 22 - Early Action Capital Improvement Projects		5106	01-Apr-09 A	04-Apr-23	Para 22 - Early Action Capital Improvement Projects																																																							

Summary
 Actual Work
 Remaining Work
 Critical Remaining Work
 Baseline Milestone

CHATTANOOGA CONSENT DECREE PROGRAM - PHASE I-2
CITY OF CHATTANOOGA, TN
WASTEWATER DEPARTMENT

Activity ID	Activity Name	At Completion Duration	Start	Finish	2013				2014				2015				2016				2017				2018				2019				2020				2021				2022				2023				2024				2025				2026			
					Q1	Q2	Q3	Q4	Q1	Q2	Q3	Q4	Q1	Q2	Q3	Q4	Q1	Q2	Q3	Q4	Q1	Q2	Q3	Q4	Q1	Q2	Q3	Q4	Q1	Q2	Q3	Q4	Q1	Q2	Q3	Q4	Q1	Q2	Q3	Q4	Q1	Q2	Q3	Q4	Q1	Q2	Q3	Q4	Q1	Q2	Q3	Q4								
SSO and Wet Weather Volume Reduction Projects																																																												
DuPont PS and Basin Improvements - Phase 1																																																												
Consent Decree Duration (60 Months)		1826	24-Apr-13 A	24-Apr-18 A																																																								
AN1040	Consent Decree Duration	1826	24-Apr-13 A	24-Apr-18 A																																																								
AN1050	Consent Decree Duration Completion Milestone	0		24-Apr-18 A																																																								
Project Procurement																																																												
AN1090	CD Prequalification Procurement (FY 2012 - 2013) Priority II - Development and Issuance of RFP	66	12-Dec-12 A	15-Feb-13 A																																																								
AN1100	Consultant develops and Submit Scope and Cost proposal	13	16-Feb-13 A	01-Mar-13 A																																																								
AN1110	PMO Reviews/ Negotiates and Approve Proposal / Agreement	13	02-Mar-13 A	15-Mar-13 A																																																								
AN1120	PMO Approved Agreement to Council for Approval	6	16-Mar-13 A	22-Mar-13 A																																																								
AN1130	Consultant Signed Agreement to City for Execution	26	23-Mar-13 A	18-Apr-13 A																																																								
Planning Phase																																																												
AN1000	Planning Phase	690	10-Feb-13 A	01-Jan-15 A																																																								
AN1060	SRF Facility Plan Approval	74	02-Jan-15 A	16-Mar-15 A																																																								
Engineering Phase																																																												
AN1010	Engineering	508	02-Apr-14 A	23-Aug-15 A																																																								
AN1020	SRF Approval of Contract Documents	100	24-Aug-15 A	02-Dec-15 A																																																								
Construction Bidding Phase																																																												
AN1070	Construction Bidding Phase	104	03-Dec-15 A	15-Mar-16 A																																																								
AN1140	SRF Administration Period	29	16-Mar-16 A	14-Apr-16 A																																																								
Construction Phase																																																												
AN1080	Construction Phase	715	15-Apr-16 A	31-Mar-18 A																																																								
EPA and TDEC Approvals																																																												
AN1030	Notification of Completion to EPA, TDEC, TCWN	0	31-Jul-18 A	31-Jul-18 A																																																								
DuPont PS and Basin Improvements - Phase 2																																																												
Consent Decree Duration (60 Months)		1826	24-Apr-13 A	24-Apr-18 A																																																								
AO1040	Consent Decree Duration	1826	24-Apr-13 A	24-Apr-18 A																																																								
AO1050	Consent Decree Duration Completion Milestone	0		24-Apr-18 A																																																								
Project Procurement																																																												
AO1090	CD Prequalification Procurement (FY 2014 - 2015) - Development and Issuance of RFP	6	25-Apr-15 A	01-May-15 A																																																								
AO1100	Consultant develops and Submit Scope and Cost proposal	7	02-May-15 A	09-May-15 A																																																								
AO1110	PMO Reviews/ Negotiates and Approve Proposal / Agreement	6	10-May-15 A	16-May-15 A																																																								
AO1120	PMO Approved Agreement to Council for Approval	22	17-May-15 A	08-Jun-15 A																																																								
AO1130	Consultant Signed Agreement to City for Execution	14	09-Jun-15 A	23-Jun-15 A																																																								
Planning Phase																																																												
AO1000	Planning Phase	128	18-Dec-17 A	25-Apr-18 A																																																								
Engineering Phase																																																												
AO1010	Engineering	591	05-Apr-18 A	17-Nov-19 A																																																								
AO1020	SRF Approval of Contract Documents	409	27-Sep-19 A	09-Nov-20 A																																																								

Summary
 Actual Work
 Remaining Work
 Critical Remaining Work
 Baseline Milestone

CHATTANOOGA CONSENT DECREE PROGRAM - PHASE I-2
CITY OF CHATTANOOGA, TN
WASTEWATER DEPARTMENT

Activity ID	Activity Name	At Completion Duration	Start	Finish	Timeline																																	
					2013	2014	2015	2016	2017	2018	2019	2020	2021	2022	2023	2024	2025	2026																				
Construction Bidding Phase																																						
AO1070	Construction Bidding Phase	483	18-Nov-19 A	15-Mar-21 A																																		
Construction Phase																																						
AO1080	Construction Phase	691	15-Mar-21 A	03-Feb-23																																		
Project Closeout																																						
AO1140	Project Closeout	60	04-Feb-23	04-Apr-23																																		
Collegedale PS Improvements																																						
AC1040	Consent Decree Duration	1826	24-Apr-13 A	24-Apr-18 A	Consent Decree Duration (60 Months)																																	
AC1050	Consent Decree Duration Completion Milestone	0		24-Apr-18 A	Consent Decree Duration Completion Milestone																																	
Project Procurement																																						
AC1090	CD Prequalification Procurement (FY 2012 - 2013) Priority I - Development and Issuance of RFP	45	18-Oct-12 A	01-Dec-12 A	Prequalification Procurement (FY 2012 - 2013) Priority I - Development and Issuance of RFP																																	
AC1100	Consultant develops and Submit Scope and Cost proposal	10	02-Dec-12 A	11-Dec-12 A	Consultant develops and Submit Scope and Cost proposal																																	
AC1110	PMO Reviews/ Negotiates and Approve Proposal / Agreement	10	12-Dec-12 A	21-Dec-12 A	PMO Reviews/ Negotiates and Approve Proposal / Agreement																																	
AC1120	PMO Approved Agreement to Council for Approval	18	22-Dec-12 A	08-Jan-13 A	PMO Approved Agreement to Council for Approval																																	
AC1130	Consultant Signed Agreement to City for Execution	14	09-Jan-13 A	22-Jan-13 A	Consultant Signed Agreement to City for Execution																																	
Planning Phase																																						
AC1000	Planning Phase	765	10-Feb-13 A	16-Mar-15 A	Planning Phase																																	
AC1060	SRF Facility Plan Approval	509	24-Oct-13 A	16-Mar-15 A	SRF Facility Plan Approval																																	
Engineering Phase																																						
AC1010	Engineering	973	02-Apr-14 A	30-Nov-16 A	Engineering Phase																																	
EPA and TDEC Approvals																																						
AC1030	Notification of Completion to EPA, TDEC, TCWN	0	30-Nov-16 A	30-Nov-16 A	EPA and TDEC Approvals																																	
East Brainerd Collection Sys. and PS Rehab																																						
OX1040	Consent Decree Duration	1826	24-Apr-13 A	24-Apr-18 A	Consent Decree Duration (60 Months)																																	
OX1050	Consent Decree Duration Completion Milestone	0		24-Apr-18 A	Consent Decree Duration Completion Milestone																																	
Project Procurement																																						
OX1090	Previously Procured Consent Decree Projects	0	07-Sep-12 A	07-Sep-12 A	Previously Procured Consent Decree Projects																																	
Planning Phase																																						
OX1000	Planning Phase	796	26-Mar-11 A	30-May-13 A	Planning Phase																																	
OX1060	SRF Facility Plan Approval	201	07-Sep-12 A	26-Mar-13 A	SRF Facility Plan Approval																																	
Collection System																																						
OX1015	Engineering - Collection System	203	07-Sep-12 A	29-Mar-13 A	Engineering - Collection System																																	
OX1100	SRF Approval of Contract Documents - Collection System	129	30-Mar-13 A	06-Aug-13 A	SRF Approval of Contract Documents - Collection System																																	
Pump Station																																						
OX1010	Engineering - Pump Station	934	10-Jan-12 A	01-Aug-14 A	Engineering - Pump Station																																	
OX1020	SRF Approval of Contract Documents - Pump Station	180	02-Aug-14 A	29-Jan-15 A	SRF Approval of Contract Documents - Pump Station																																	
Collection System																																						
OX1075	Construction Bidding Phase - Collection System	132	07-Aug-13 A	17-Dec-13 A	Collection System																																	

- Summary
- Actual Work
- Remaining Work
- Critical Remaining Work
- Baseline Milestone

CHATTANOOGA CONSENT DECREE PROGRAM - PHASE I-2 CITY OF CHATTANOOGA, TN WASTEWATER DEPARTMENT

Activity ID	Activity Name	At Completion Duration	Start	Finish	2013				2014				2015				2016				2017				2018				2019				2020				2021				2022				2023				2024				2025				2026			
					Q1	Q2	Q3	Q4	Q1	Q2	Q3	Q4	Q1	Q2	Q3	Q4	Q1	Q2	Q3	Q4	Q1	Q2	Q3	Q4	Q1	Q2	Q3	Q4	Q1	Q2	Q3	Q4	Q1	Q2	Q3	Q4	Q1	Q2	Q3	Q4	Q1	Q2	Q3	Q4	Q1	Q2	Q3	Q4	Q1	Q2	Q3	Q4								
OZ1090	Previously Procured Consent Decree Projects	1	01-Mar-11 A	01-Mar-11 A	Projects																																																							
Planning Phase		189	11-Apr-11 A	17-Oct-11 A																																																								
OZ1000	Planning Phase	158	11-Apr-11 A	16-Sep-11 A																																																								
OZ1060	SRF Facility Plan Approval	31	16-Sep-11 A	17-Oct-11 A	al																																																							
Engineering Phase		760	16-Sep-11 A	15-Oct-13 A																																																								
OZ1010	Engineering	760	16-Sep-11 A	15-Oct-13 A																																																								
OZ1020	SRF Approval of Contract Documents	745	16-Sep-11 A	30-Sep-13 A	Documents																																																							
Construction Bidding Phase		136	17-Oct-13 A	02-Mar-14 A																																																								
OZ1070	Construction Bidding Phase	22	17-Oct-13 A	08-Nov-13 A	Construction Bidding Phase																																																							
OZ1100	SRF Administration Period	113	09-Nov-13 A	02-Mar-14 A	SRF Administration Period																																																							
Construction Phase		199	03-Mar-14 A	18-Sep-14 A																																																								
OZ1080	Construction Phase	199	03-Mar-14 A	18-Sep-14 A	Construction Phase																																																							
EPA and TDEC Approvals		0	18-Sep-14 A	18-Sep-14 A																																																								
OZ1030	Notification of Completion to EPA, TDEC, TCWN	0	18-Sep-14 A	18-Sep-14 A	EPA and TDEC Approvals Notification of Completion to EPA, TDEC, TCWN																																																							
Citico Creek Interceptor Rehab		2569	01-Apr-09 A	24-Apr-16 A																																																								
Consent Decree Duration (36 Months)		1096	24-Apr-13 A	24-Apr-16 A	Consent Decree Duration (36 Months)																																																							
OW1040	Consent Decree Duration	1096	24-Apr-13 A	24-Apr-16 A	Consent Decree Duration																																																							
OW1050	Consent Decree Duration Completion Milestone	0		24-Apr-16 A	Consent Decree Duration Completion Milestone																																																							
Project Procurement		90	01-Apr-09 A	29-Jun-09 A																																																								
A4440	Project Procurement	90	01-Apr-09 A	29-Jun-09 A																																																								
Planning Phase		63	30-Jun-09 A	01-Sep-09 A																																																								
OW1000	Planning Phase	63	30-Jun-09 A	01-Sep-09 A																																																								
OW1060	SRF Facility Plan Approval	0	30-Jun-09 A	30-Jun-09 A																																																								
Engineering Phase		390	01-Jul-09 A	01-Aug-10 A																																																								
OW1010	Engineering	390	01-Jul-09 A	01-Aug-10 A																																																								
OW1020	SRF Approval of Contract Documents	0	01-Jul-09 A	01-Jul-09 A																																																								
Construction Bidding Phase		31	01-Aug-12 A	01-Sep-12 A																																																								
OW1070	Construction Bidding Phase	31	01-Aug-12 A	01-Sep-12 A	tion Bidding Phase																																																							
Construction Phase		389	03-Jun-13 A	27-Jun-14 A																																																								
OW1080	Construction Phase	389	03-Jun-13 A	27-Jun-14 A	Construction Phase																																																							
EPA and TDEC Approvals		0	30-Jul-14 A	30-Jul-14 A																																																								
OW1030	Notification of Completion to EPA, TDEC, TCWN	0	30-Jul-14 A	30-Jul-14 A	EPA and TDEC Approvals Notification of Completion to EPA, TDEC, TCWN																																																							
Highland Park Sewer Rehab		2057	12-Dec-12 A	31-Jul-18 A																																																								
Consent Decree Duration (60 Months)		1826	24-Apr-13 A	24-Apr-18 A	Consent Decree Duration (60 Months)																																																							
AD1040	Consent Decree Duration	1826	24-Apr-13 A	24-Apr-18 A	Consent Decree Duration																																																							
AD1050	Consent Decree Duration Completion Milestone	0		24-Apr-18 A	Consent Decree Duration Completion Milestone																																																							
Project Procurement		128	12-Dec-12 A	18-Apr-13 A																																																								
AD1090	CD Prequalification Procurement (FY 2012 - 2013) Priority II - Development and Issuance of RFP	66	12-Dec-12 A	15-Feb-13 A	Project Procurement CD Prequalification Procurement (FY 2012 - 2013) Priority II - Development and Issuance of RFP																																																							
AD1100	Consultant develops and Submit Scope and Cost proposal	14	16-Feb-13 A	01-Mar-13 A	Consultant develops and Submit Scope and Cost proposal																																																							
AD1110	PMO Reviews/ Negotiates and Approve Proposal / Agreement	14	02-Mar-13 A	15-Mar-13 A	PMO Reviews/ Negotiates and Approve Proposal / Agreement																																																							

Summary
 Actual Work
 Remaining Work
 Critical Remaining Work
 Baseline Milestone

CHATTANOOGA CONSENT DECREE PROGRAM - PHASE I-2

CITY OF CHATTANOOGA, TN WASTEWATER DEPARTMENT

Activity ID	Activity Name	At Completion Duration	Start	Finish	2013				2014				2015				2016				2017				2018				2019				2020				2021				2022				2023				2024				2025				2026			
					Q1	Q2	Q3	Q4	Q1	Q2	Q3	Q4	Q1	Q2	Q3	Q4	Q1	Q2	Q3	Q4	Q1	Q2	Q3	Q4	Q1	Q2	Q3	Q4	Q1	Q2	Q3	Q4	Q1	Q2	Q3	Q4	Q1	Q2	Q3	Q4	Q1	Q2	Q3	Q4	Q1	Q2	Q3	Q4	Q1	Q2	Q3	Q4								
AD1120	PMO Approved Agreement to Council for Approval	7	16-Mar-13 A	22-Mar-13 A	PMO Approved Agreement to Council for Approval																																																							
AD1130	Consultant Signed Agreement to City for Execution	27	23-Mar-13 A	18-Apr-13 A	Consultant Signed Agreement to City for Execution																																																							
Planning Phase																																																												
AD1000	Planning Phase	721	19-Apr-13 A	10-Apr-15 A	Planning Phase																																																							
AD1060	SRF Facility Plan Approval	186	24-Oct-13 A	28-Apr-14 A	SRF Facility Plan Approval																																																							
Engineering Phase																																																												
AD1010	Engineering	265	10-Apr-15 A	30-Dec-15 A	Engineering																																																							
AD1020	SRF Approval of Contract Documents	117	31-Dec-15 A	26-Apr-16 A	SRF Approval of Contract Documents																																																							
Construction Bidding Phase																																																												
AD1070	Construction Bidding Phase	111	27-Apr-16 A	16-Aug-16 A	Construction Bidding Phase																																																							
AD1140	SRF Administration Phase	44	17-Aug-16 A	30-Sep-16 A	SRF Administration Phase																																																							
Construction Phase																																																												
AD1080	Construction Phase	424	30-Sep-16 A	28-Nov-17 A	Construction Phase																																																							
EPA and TDEC Approvals																																																												
AD1030	Notification of Completion to EPA, TDEC, TCWN	0	31-Jul-18 A	31-Jul-18 A	EPA and TDEC Approvals Notification of Completion to EPA, TDEC, TCWN																																																							
Citico CSOTF PS Improvement Study																																																												
Consent Decree Duration (36 Months)																																																												
AM1040	Consent Decree Duration	1096	24-Apr-13 A	24-Apr-16 A	Consent Decree Duration																																																							
AM1050	Consent Decree Duration Completion Milestone	0		24-Apr-16 A	Consent Decree Duration Completion Milestone																																																							
Project Procurement																																																												
AM1090	CD Prequalification Procurement (FY 2012 - 2013) Priority I - Development and Issuance of RFP	45	18-Oct-12 A	01-Dec-12 A	Prequalification Procurement (FY 2012 - 2013) Priority I - Development and Issuance of RFP																																																							
AM1100	Consultant develops and Submit Scope and Cost proposal	10	02-Dec-12 A	11-Dec-12 A	Consultant develops and Submit Scope and Cost proposal																																																							
AM1110	PMO Reviews/ Negotiates and Approve Proposal / Agreement	10	12-Dec-12 A	21-Dec-12 A	PMO Reviews/ Negotiates and Approve Proposal / Agreement																																																							
AM1120	PMO Approved Agreement to Council for Approval	18	22-Dec-12 A	08-Jan-13 A	PMO Approved Agreement to Council for Approval																																																							
AM1130	Consultant Signed Agreement to City for Execution	14	09-Jan-13 A	22-Jan-13 A	Consultant Signed Agreement to City for Execution																																																							
Planning Phase																																																												
AM1060	SRF Facility Plan Approval	0	23-Jan-13 A	23-Jan-13 A	SRF Facility Plan Approval																																																							
AM1000	Planning Phase	656	23-Jan-13 A	10-Nov-14 A	Planning Phase																																																							
Project Completion Report																																																												
OI2280	Project Completion Report	0	10-Nov-14 A	10-Nov-14 A	Project Completion Report																																																							
EPA and TDEC Approvals																																																												
AM1030	Notification of Completion to EPA, TDEC, TCWN	0	10-Nov-14 A	10-Nov-14 A	EPA and TDEC Approvals Notification of Completion to EPA, TDEC, TCWN																																																							
Tremont Area Sewer Separation Study																																																												
Consent Decree Duration (36 Months)																																																												
OU1040	Consent Decree Duration	1096	24-Apr-13 A	24-Apr-16 A	Consent Decree Duration																																																							
OU1050	Consent Decree Duration Completion Milestone	0		24-Apr-16 A	Consent Decree Duration Completion Milestone																																																							
Project Procurement																																																												
OU1090	Previously Procured Consent Decree Projects	175	07-Sep-12 A	28-Feb-13 A	Previously Procured Consent Decree Projects																																																							
Planning Phase																																																												
OU1000	Planning Phase	447	01-Mar-13 A	22-May-14 A	Planning Phase																																																							

Summary
 Actual Work
 Remaining Work
 Critical Remaining Work
 Baseline Milestone

CHATTANOOGA CONSENT DECREE PROGRAM - PHASE I-2
CITY OF CHATTANOOGA, TN
WASTEWATER DEPARTMENT

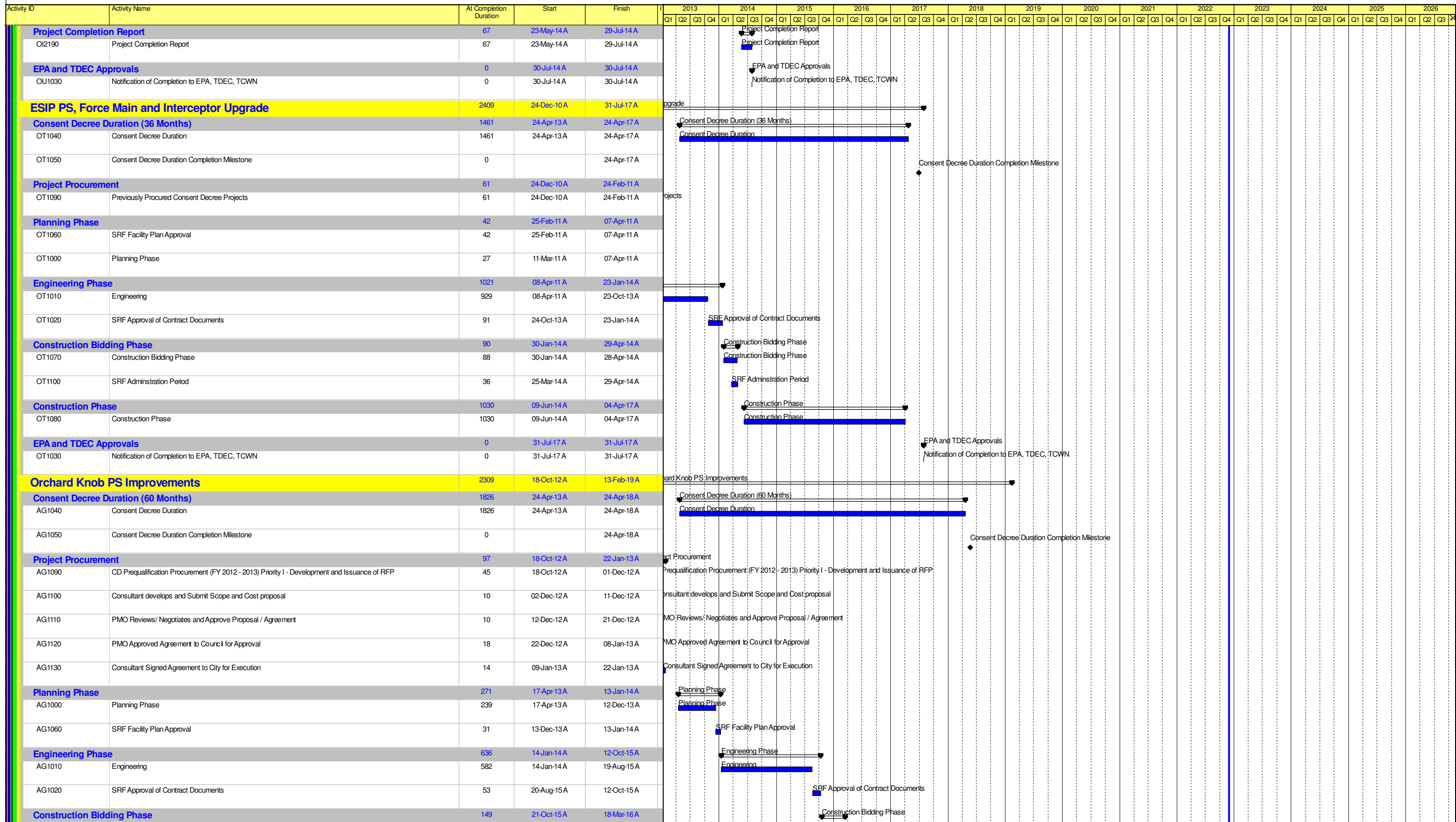

- Summary
- Actual Work
- Remaining Work
- Critical Remaining Work
- Baseline Milestone

CHATTANOOGA CONSENT DECREE PROGRAM - PHASE I-2
CITY OF CHATTANOOGA, TN
WASTEWATER DEPARTMENT

Activity ID	Activity Name	At Completion Duration	Start	Finish	2013				2014				2015				2016				2017				2018				2019				2020				2021				2022				2023				2024				2025				2026			
					Q1	Q2	Q3	Q4	Q1	Q2	Q3	Q4	Q1	Q2	Q3	Q4	Q1	Q2	Q3	Q4	Q1	Q2	Q3	Q4	Q1	Q2	Q3	Q4	Q1	Q2	Q3	Q4	Q1	Q2	Q3	Q4	Q1	Q2	Q3	Q4	Q1	Q2	Q3	Q4	Q1	Q2	Q3	Q4	Q1	Q2	Q3	Q4								
AE1120	PMO Approved Agreement to Council for Approval	7	16-Mar-13 A	22-Mar-13 A	PMO Approved Agreement to Council for Approval																																																							
AE1130	Consultant Signed Agreement to City for Execution	27	23-Mar-13 A	18-Apr-13 A	Consultant Signed Agreement to City for Execution																																																							
Planning Phase																																																												
AE1000	Planning Phase	457	29-Apr-13 A	30-Jul-14 A	Planning Phase																																																							
AE1060	SRF Facility Plan Approval	186	24-Oct-13 A	28-Apr-14 A	SRF Facility Plan Approval																																																							
Engineering Phase																																																												
AE1010	Engineering	956	12-May-14 A	23-Dec-16 A	Engineering																																																							
AE1020	SRF Approval of Contract Documents	90	24-Dec-16 A	24-Mar-17 A	SRF Approval of Contract Documents																																																							
Construction Bidding Phase																																																												
AE1070	Construction Bidding Phase	124	24-Dec-16 A	27-Apr-17 A	Construction Bidding Phase																																																							
AE1140	SRF Administration Period	20	14-Apr-17 A	04-May-17 A	SRF Administration Period																																																							
Construction Phase																																																												
AE1080	Construction Phase	561	28-Apr-17 A	10-Nov-18 A	Construction Phase																																																							
A9950	Construction Substantial Completion	0		29-Jun-18 A	Construction Substantial Completion																																																							
EPA and TDEC Approvals																																																												
AE1030	Notification of Completion to EPA, TDEC, TCWN	0	31-Jul-18 A	31-Jul-18 A	EPA and TDEC Approvals																																																							
Chattanooga Creek Interceptor Rehab																																																												
Consent Decree Duration (36 Months)																																																												
AB1040	Consent Decree Duration	1096	24-Apr-13 A	24-Apr-16 A	Consent Decree Duration																																																							
AB1050	Consent Decree Duration Completion Milestone	0		24-Apr-16 A	Consent Decree Duration Completion Milestone																																																							
Project Procurement																																																												
AB1090	CD Prequalification Procurement (FY 2012 - 2013) Priority II - Development and Issuance of RFP	66	12-Dec-12 A	15-Feb-13 A	CD Prequalification Procurement (FY 2012 - 2013) Priority II - Development and Issuance of RFP																																																							
AB1100	Consultant develops and Submit Scope and Cost proposal	14	16-Feb-13 A	01-Mar-13 A	Consultant develops and Submit Scope and Cost proposal																																																							
AB1110	PMO Reviews/ Negotiates and Approve Proposal / Agreement	14	02-Mar-13 A	15-Mar-13 A	PMO Reviews/ Negotiates and Approve Proposal / Agreement																																																							
AB1120	PMO Approved Agreement to Council for Approval	7	16-Mar-13 A	22-Mar-13 A	PMO Approved Agreement to Council for Approval																																																							
AB1130	Consultant Signed Agreement to City for Execution	27	23-Mar-13 A	18-Apr-13 A	Consultant Signed Agreement to City for Execution																																																							
Planning Phase																																																												
AB1000	Planning Phase	361	06-May-13 A	02-May-14 A	Planning Phase																																																							
AB1060	SRF Facility Plan Approval	186	24-Oct-13 A	28-Apr-14 A	SRF Facility Plan Approval																																																							
Engineering Phase																																																												
AB1010	Engineering	227	05-May-14 A	18-Dec-14 A	Engineering																																																							
AB1020	SRF Approval of Contract Documents	42	19-Dec-14 A	30-Jan-15 A	SRF Approval of Contract Documents																																																							
Construction Bidding Phase																																																												
AB1070	Construction Bidding Phase	106	02-Feb-15 A	19-May-15 A	Construction Bidding Phase																																																							
AB1140	SRF Administration Period	22	20-May-15 A	11-Jun-15 A	SRF Administration Period																																																							
Construction Phase																																																												
AB1080	Construction Phase	379	14-Jul-15 A	27-Jul-16 A	Construction Phase																																																							
EPA and TDEC Approvals																																																												
AB1030	Notification of Completion to EPA, TDEC, TCWN	0	27-Jul-16 A	27-Jul-16 A	EPA and TDEC Approvals																																																							

Summary
 Actual Work
 Remaining Work
 Critical Remaining Work
 Baseline Milestone

CHATTANOOGA CONSENT DECREE PROGRAM - PHASE I-2
CITY OF CHATTANOOGA, TN
WASTEWATER DEPARTMENT

Activity ID	Activity Name	At Completion Duration	Start	Finish	2013				2014				2015				2016				2017				2018				2019				2020				2021				2022				2023				2024				2025				2026			
					Q1	Q2	Q3	Q4	Q1	Q2	Q3	Q4	Q1	Q2	Q3	Q4	Q1	Q2	Q3	Q4	Q1	Q2	Q3	Q4	Q1	Q2	Q3	Q4	Q1	Q2	Q3	Q4	Q1	Q2	Q3	Q4	Q1	Q2	Q3	Q4	Q1	Q2	Q3	Q4	Q1	Q2	Q3	Q4	Q1	Q2	Q3	Q4								
Tannery Flats Interceptor Rehab					Tannery Flats Interceptor Rehab																																																							
Consent Decree Duration (36 Months)					Consent Decree Duration (36 Months)																																																							
AA1040	Consent Decree Duration	1096	24-Apr-13 A	24-Apr-16 A	Consent Decree Duration																																																							
AA1050	Consent Decree Duration Completion Milestone	0		24-Apr-16 A	Consent Decree Duration Completion Milestone																																																							
Project Procurement					Project Procurement																																																							
AA1090	CD Prequalification Procurement (FY 2012 - 2013) Priority II - Development and Issuance of RFP	66	12-Dec-12 A	15-Feb-13 A	CD Prequalification Procurement (FY 2012 - 2013) Priority II - Development and Issuance of RFP																																																							
AA1100	Consultant develops and Submit Scope and Cost proposal	14	16-Feb-13 A	01-Mar-13 A	Consultant develops and Submit Scope and Cost proposal																																																							
AA1110	PMO Reviews/ Negotiates and Approve Proposal / Agreement	14	02-Mar-13 A	15-Mar-13 A	PMO Reviews/ Negotiates and Approve Proposal / Agreement																																																							
AA1120	PMO Approved Agreement to Council for Approval	7	16-Mar-13 A	22-Mar-13 A	PMO Approved Agreement to Council for Approval																																																							
AA1130	Consultant Signed Agreement to City for Execution	27	23-Mar-13 A	18-Apr-13 A	Consultant Signed Agreement to City for Execution																																																							
Planning Phase					Planning Phase																																																							
AA1000	Planning Phase	51	20-Apr-13 A	10-Jun-13 A	Planning Phase																																																							
AA1060	SRF Facility Plan Approval	191	11-Jun-13 A	19-Dec-13 A	SRF Facility Plan Approval																																																							
Engineering Phase					Engineering Phase																																																							
AA1010	Engineering	381	20-Dec-13 A	05-Jan-15 A	Engineering																																																							
AA1020	SRF Approval of Contract Documents	35	06-Jan-15 A	10-Feb-15 A	SRF Approval of Contract Documents																																																							
Construction Bidding Phase					Construction Bidding Phase																																																							
AA1070	Construction Bidding Phase	109	19-Feb-15 A	08-Jun-15 A	Construction Bidding Phase																																																							
AA1140	SRF Administration Period	15	09-Jun-15 A	24-Jun-15 A	SRF Administration Period																																																							
Construction Phase					Construction Phase																																																							
AA1080	Construction Phase	297	25-Jun-15 A	17-Apr-16 A	Construction Phase																																																							
EPA and TDEC Approvals					EPA and TDEC Approvals																																																							
AA1030	Notification of Completion to EPA, TDEC, TCWN	0	17-Apr-16 A	17-Apr-16 A	Notification of Completion to EPA, TDEC, TCWN																																																							
EB/WB Flow Monitoring					EB/WB Flow Monitoring																																																							
Consent Decree Duration (36 Months)					Consent Decree Duration (36 Months)																																																							
AC1450	Consent Decree Duration	1096	24-Apr-13 A	24-Apr-16 A	Consent Decree Duration																																																							
AC1460	Consent Decree Duration Completion Milestone	0		24-Apr-16 A	Consent Decree Duration Completion Milestone																																																							
Project Procurement					Project Procurement																																																							
AC1470	PM Procurement	45	15-Jul-12 A	28-Aug-12 A	PM Procurement																																																							
Planning Phase					Planning Phase																																																							
AC1530	SRF Facility Plan Approval	0	20-Oct-12 A	20-Oct-12 A	SRF Facility Plan Approval																																																							
AC1520	Planning Phase	177	20-Oct-12 A	15-Apr-13 A	Planning Phase																																																							
Engineering Phase					Engineering Phase																																																							
AC1540	Flow Monitoring by West Bank Flow Meter	271	16-Apr-13 A	11-Jan-14 A	Flow Monitoring by West Bank Flow Meter																																																							
AC1550	SRF Approval of Contract Documents	0	16-Apr-13 A	16-Apr-13 A	SRF Approval of Contract Documents																																																							
AC1545	Flow Monitoring by New Outfall Flow Meter	574	16-Apr-13 A	11-Nov-14 A	Flow Monitoring by New Outfall Flow Meter																																																							
Construction Bidding Phase					Construction Bidding Phase																																																							
AC1560	Construction Bidding Phase	0	11-Nov-14 A	11-Nov-14 A	Construction Bidding Phase																																																							
AC1570	SRF Administration Period	0	11-Nov-14 A	11-Nov-14 A	SRF Administration Period																																																							
Construction Phase					Construction Phase																																																							
		833	12-Jan-14 A	24-Apr-16 A	Construction Phase																																																							

Summary
 Actual Work
 Remaining Work
 Critical Remaining Work
 Baseline Milestone

CHATTANOOGA CONSENT DECREE PROGRAM - PHASE I-2
CITY OF CHATTANOOGA, TN
WASTEWATER DEPARTMENT

Activity ID	Activity Name	At Completion Duration	Start	Finish	2013												2014				2015				2016				2017				2018				2019				2020				2021				2022				2023				2024				2025				2026			
					Q1	Q2	Q3	Q4	Q1	Q2	Q3	Q4	Q1	Q2	Q3	Q4	Q1	Q2	Q3	Q4	Q1	Q2	Q3	Q4	Q1	Q2	Q3	Q4	Q1	Q2	Q3	Q4	Q1	Q2	Q3	Q4	Q1	Q2	Q3	Q4	Q1	Q2	Q3	Q4	Q1	Q2	Q3	Q4	Q1	Q2	Q3	Q4	Q1	Q2	Q3	Q4	Q1	Q2	Q3	Q4	Q1	Q2	Q3	Q4	Q1	Q2	Q3	Q4
AK1080	Construction Phase	520	16-Feb-15 A	20-Jul-16 A	[Gantt bars showing work from 2015 to 2016]																																																															
EPA and TDEC Approvals					[Summary bar for EPA and TDEC Approvals from 2015 to 2016]																																																															
A4660	Notification of Completion to EPA, TDEC, TCWN	10	21-Jul-16 A	31-Jul-16 A	[Gantt bar for notification of completion from 2016]																																																															
MBWWTP Bar and Fine Screen Replacements					[Summary bar for MBWWTP Bar and Fine Screen Replacements from 2015 to 2016]																																																															
Consent Decree Duration (60 Months)					[Summary bar for Consent Decree Duration (60 Months) from 2013 to 2018]																																																															
AJ1040	Consent Decree Duration	1826	24-Apr-13 A	24-Apr-18 A	[Gantt bar for Consent Decree Duration from 2013 to 2018]																																																															
AJ1050	Consent Decree Duration Completion Milestone	0		24-Apr-18 A	[Milestone marker at 2018]																																																															
Project Procurement					[Summary bar for Project Procurement from 2012 to 2012]																																																															
AJ1090	Previously Procured Consent Decree Projects	0	07-Sep-12 A	07-Sep-12 A	[Milestone marker at 2012]																																																															
Planning Phase					[Summary bar for Planning Phase from 2012 to 2012]																																																															
AJ1000	Planning Phase	290	01-Jan-12 A	17-Oct-12 A	[Gantt bar for Planning Phase from 2012]																																																															
AJ1060	SRF Facility Plan Approval	9	08-Oct-12 A	17-Oct-12 A	[Gantt bar for SRF Facility Plan Approval from 2012]																																																															
Engineering Phase					[Summary bar for Engineering Phase from 2012 to 2014]																																																															
AJ1010	Engineering	857	01-May-12 A	05-Sep-14 A	[Gantt bar for Engineering from 2012 to 2014]																																																															
AJ1020	SRF Approval of Contract Documents	44	06-Sep-14 A	20-Oct-14 A	[Gantt bar for SRF Approval of Contract Documents from 2014]																																																															
Construction Bidding Phase					[Summary bar for Construction Bidding Phase from 2014 to 2014]																																																															
AJ1070	Construction Bidding Phase	42	23-Oct-14 A	04-Dec-14 A	[Gantt bar for Construction Bidding Phase from 2014]																																																															
AJ1100	SRF Administration Phase	69	05-Dec-14 A	12-Feb-15 A	[Gantt bar for SRF Administration Phase from 2014]																																																															
Construction Phase					[Summary bar for Construction Phase from 2015 to 2017]																																																															
AJ1080	Construction Phase	865	16-Feb-15 A	30-Jun-17 A	[Gantt bar for Construction Phase from 2015 to 2017]																																																															
MBWWTP Effluent Disinfection System Upgrade					[Summary bar for MBWWTP Effluent Disinfection System Upgrade from 2012 to 2016]																																																															
Consent Decree Duration (36 Months)					[Summary bar for Consent Decree Duration (36 Months) from 2013 to 2016]																																																															
AC1340	Consent Decree Duration	1097	24-Apr-13 A	24-Apr-16 A	[Gantt bar for Consent Decree Duration from 2013 to 2016]																																																															
AC1350	Consent Decree Duration Completion Milestone	0		24-Apr-16 A	[Milestone marker at 2016]																																																															
Project Procurement					[Summary bar for Project Procurement from 2012 to 2013]																																																															
AC1390	CD Prequalification Procurement (FY 2012 - 2013) Priority I - Development and Issuance of RFP	45	18-Oct-12 A	01-Dec-12 A	[Gantt bar for CD Prequalification Procurement from 2012]																																																															
AC1400	Consultant develops and Submit Scope and Cost proposal	10	02-Dec-12 A	11-Dec-12 A	[Gantt bar for consultant develops and Submit Scope and Cost proposal from 2012]																																																															
AC1410	PMO Reviews/ Negotiates and Approve Proposal / Agreement	0	12-Dec-12 A	12-Dec-12 A	[Milestone marker at 2012]																																																															
AC1420	PMO Approved Agreement to Council for Approval	18	12-Dec-12 A	29-Dec-12 A	[Gantt bar for PMO Approved Agreement to Council for Approval from 2012]																																																															
AC1430	Consultant Signed Agreement to City for Execution	14	30-Dec-12 A	12-Jan-13 A	[Gantt bar for Consultant Signed Agreement to City for Execution from 2012]																																																															
Planning Phase					[Summary bar for Planning Phase from 2013 to 2013]																																																															
AC1300	Planning Phase	121	29-Apr-13 A	28-Aug-13 A	[Gantt bar for Planning Phase from 2013]																																																															
AC1360	SRF Facility Plan Approval	106	14-May-13 A	28-Aug-13 A	[Gantt bar for SRF Facility Plan Approval from 2013]																																																															
Engineering Phase					[Summary bar for Engineering Phase from 2013 to 2014]																																																															
AC1310	Engineering	375	10-Oct-13 A	20-Oct-14 A	[Gantt bar for Engineering from 2013 to 2014]																																																															
AC1320	SRF Approval of Contract Documents	47	03-Sep-14 A	20-Oct-14 A	[Gantt bar for SRF Approval of Contract Documents from 2014]																																																															
Construction Bidding Phase					[Summary bar for Construction Bidding Phase from 2014 to 2014]																																																															
AC1370	Construction Bidding Phase	92	30-Oct-14 A	30-Jan-15 A	[Gantt bar for Construction Bidding Phase from 2014]																																																															
AC1440	SRF Administration Period	66	05-Jan-15 A	30-Jan-15 A	[Gantt bar for SRF Administration Period from 2015]																																																															
Construction Phase					[Summary bar for Construction Phase from 2015 to 2015]																																																															
		405	16-Mar-15 A	24-Apr-16 A	[Gantt bar for Construction Phase from 2015]																																																															

Summary
 Actual Work
 Remaining Work
 Critical Remaining Work

CHATTANOOGA CONSENT DECREE PROGRAM - PHASE I-2

CITY OF CHATTANOOGA, TN

WASTEWATER DEPARTMENT

Baseline Milestone

Activity ID	Activity Name	At Completion Duration	Start	Finish	2013				2014				2015				2016				2017				2018				2019				2020				2021				2022				2023				2024				2025				2026			
					Q1	Q2	Q3	Q4	Q1	Q2	Q3	Q4	Q1	Q2	Q3	Q4	Q1	Q2	Q3	Q4	Q1	Q2	Q3	Q4	Q1	Q2	Q3	Q4	Q1	Q2	Q3	Q4	Q1	Q2	Q3	Q4	Q1	Q2	Q3	Q4	Q1	Q2	Q3	Q4	Q1	Q2	Q3	Q4	Q1	Q2	Q3	Q4								
AH1090	Previously Procured Consent Decree Projects	66	07-Sep-12 A	11-Nov-12 A	Previously Procured Consent Decree Projects																																																							
Planning Phase		0	12-Nov-12 A	12-Nov-12 A	Planning Phase																																																							
AH1000	Planning Phase	0	12-Nov-12 A	12-Nov-12 A	Planning Phase																																																							
AH1060	SRF Facility Plan Approval	0	12-Nov-12 A	12-Nov-12 A	SRF Facility Plan Approval																																																							
Engineering Phase		0	12-Nov-12 A	12-Nov-12 A	Engineering Phase																																																							
AH1010	Engineering	0	12-Nov-12 A	12-Nov-12 A	Engineering																																																							
AH1020	SRF Approval of Contract Documents	0	12-Nov-12 A	12-Nov-12 A	SRF Approval of Contract Documents																																																							
Construction Bidding Phase		0	12-Nov-12 A	12-Nov-12 A	Construction Bidding Phase																																																							
AH1070	Construction Bidding Phase	0	12-Nov-12 A	12-Nov-12 A	Construction Bidding Phase																																																							
Construction Phase		5	12-Nov-12 A	16-Nov-12 A	Construction Phase																																																							
AH1080	Construction Phase	5	12-Nov-12 A	16-Nov-12 A	Construction Phase																																																							
EPA and TDEC Approvals		0	30-Jan-14 A	30-Jan-14 A	EPA and TDEC Approvals																																																							
AH1030	Notification of Completion to EPA, TDEC, TCWN	0	30-Jan-14 A	30-Jan-14 A	Notification of Completion to EPA, TDEC, TCWN																																																							
MBWWTP Telemetry and SCADA Upgrades		2112	18-Oct-12 A	31-Jul-18 A	MBWWTP Telemetry and SCADA Upgrades																																																							
Consent Decree Duration (60 Months)		1826	24-Apr-13 A	24-Apr-18 A	Consent Decree Duration (60 Months)																																																							
AC1190	Consent Decree Duration	1826	24-Apr-13 A	24-Apr-18 A	Consent Decree Duration																																																							
AC1200	Consent Decree Duration Completion Milestone	0		24-Apr-18 A	Consent Decree Duration Completion Milestone																																																							
Project Procurement		97	18-Oct-12 A	22-Jan-13 A	Project Procurement																																																							
AC1240	CD Prequalification Procurement (FY 2012 - 2013) Priority I - Development and Issuance of RFP	45	18-Oct-12 A	01-Dec-12 A	Prequalification Procurement (FY 2012 - 2013) Priority I - Development and Issuance of RFP																																																							
AC1250	Consultant develops and Submit Scope and Cost proposal	10	02-Dec-12 A	11-Dec-12 A	Consultant develops and Submit Scope and Cost proposal																																																							
AC1260	PMO Reviews/ Negotiates and Approve Proposal / Agreement	10	12-Dec-12 A	21-Dec-12 A	PMO Reviews/ Negotiates and Approve Proposal / Agreement																																																							
AC1270	PMO Approved Agreement to Council for Approval	18	22-Dec-12 A	08-Jan-13 A	PMO Approved Agreement to Council for Approval																																																							
AC1280	Consultant Signed Agreement to City for Execution	14	09-Jan-13 A	22-Jan-13 A	Consultant Signed Agreement to City for Execution																																																							
Planning Phase		106	27-Mar-13 A	11-Jul-13 A	Planning Phase																																																							
AC1150	Planning Phase	75	27-Mar-13 A	10-Jun-13 A	Planning Phase																																																							
AC1210	SRF Facility Plan Approval	30	11-Jun-13 A	11-Jul-13 A	SRF Facility Plan Approval																																																							
Engineering Phase		851	12-Jul-13 A	10-Nov-15 A	Engineering Phase																																																							
AC1160	Engineering	826	12-Jul-13 A	16-Oct-15 A	Engineering																																																							
AC1170	SRF Approval of Contract Documents	24	17-Oct-15 A	10-Nov-15 A	SRF Approval of Contract Documents																																																							
Construction Bidding Phase		387	10-Nov-15 A	01-Dec-16 A	Construction Bidding Phase																																																							
AC1220	Construction Bidding Phase	363	10-Nov-15 A	07-Nov-16 A	Construction Bidding Phase																																																							
AC1290	SRF Administration Period	24	07-Nov-16 A	01-Dec-16 A	SRF Administration Period																																																							
Construction Phase		380	13-Nov-16 A	28-Nov-17 A	Construction Phase																																																							
AC1230	Construction Phase	380	13-Nov-16 A	28-Nov-17 A	Construction Phase																																																							
EPA and TDEC Approvals		0	31-Jul-18 A	31-Jul-18 A	EPA and TDEC Approvals																																																							
AC1180	Notification of Completion to EPA, TDEC, TCWN	0	31-Jul-18 A	31-Jul-18 A	Notification of Completion to EPA, TDEC, TCWN																																																							
Para 23 - East Bank/West Bank Outfall Assessment and Rehabilitation Plan		2558	26-Nov-23	26-Nov-30	Para 23 - East Bank/West Bank Outfall Assessment and Rehabilitation Plan																																																							
East Bank/West Bank Outfall Assessment and Rehabilitation Plan		2558	26-Nov-23	26-Nov-30	East Bank/West Bank Outfall Assessment and Rehabilitation Plan																																																							
East Bank/West Bank Outfall Assessment and Rehabilitation Plan		2558	26-Nov-23	26-Nov-30	East Bank/West Bank Outfall Assessment and Rehabilitation Plan																																																							
AH1100	East Bank/West Bank Outfall Assessment and Rehabilitation Plan	0	26-Nov-23	26-Nov-23	East Bank/West Bank Outfall Assessment and Rehabilitation Plan																																																							

Summary
 Actual Work
 Remaining Work
 Critical Remaining Work
 Baseline Milestone

CHATTANOOGA CONSENT DECREE PROGRAM - PHASE I-2
CITY OF CHATTANOOGA, TN
WASTEWATER DEPARTMENT

Activity ID	Activity Name	At Completion Duration	Start	Finish	2013	2014	2015	2016	2017	2018	2019	2020	2021	2022	2023	2024	2025	2026	
					Q1	Q2	Q3	Q4	Q1	Q2	Q3	Q4	Q1	Q2	Q3	Q4	Q1	Q2	Q3
OO1220	Consent Decree Duration	579	24-Apr-13 A	24-Nov-14 A	Consent Decree Duration														
OO1230	Consent Decree Duration Completion Milestone	0		24-Nov-14 A	Consent Decree Duration Completion Milestone														
Project Procurement																			
OO1110	Program Manager (PM) Procurement (FY 2012 - 2013)	0	15-Jul-12 A	15-Jul-12 A	Procurement Manager (PM) Procurement (FY 2012 - 2013)														
OO1240	Administration Phase	351	15-Jul-12 A	01-Jul-13 A	Administration Phase														
Planning Phase																			
OO1120	Planning Phase	333	02-Jul-13 A	31-May-14 A	Planning Phase														
OO1400	Program Manager / Owner Review and Coordination	133	01-Jun-14 A	12-Oct-14 A	Program Manager / Owner Review and Coordination														
Public Document Repository																			
OO1130	Submit Draft Deliverable to Reference Librarian	0	13-Oct-14 A	13-Oct-14 A	Submit Draft Deliverable to Reference Librarian														
OO1140	Post Copy of Draft Deliverable on City's Website	0	13-Oct-14 A	13-Oct-14 A	Post Copy of Draft Deliverable on City's Website														
OO1150	Public Review Period	35	13-Oct-14 A	17-Nov-14 A	Public Review Period														
OO1160	Public Comment Review Period	1	17-Nov-14 A	18-Nov-14 A	Public Comment Review Period														
OO1170	Submit Deliverable to EPA, TDEC and Provide notice to TCWN	0		18-Nov-14 A	Submit Deliverable to EPA, TDEC and Provide notice to TCWN														
EPA and TDEC Approvals																			
OO1180	Place Copy of EPA and TDEC Submittal in PDR	6	18-Nov-14 A	24-Nov-14 A	Place Copy of EPA and TDEC Submittal in PDR														
OO1190	EPA / TDEC Review	113	19-Nov-14 A	12-Mar-15 A	EPA / TDEC Review														
OO1200	Address Comments for Final EPA / TDEC Approval	0	12-Mar-15 A	12-Mar-15 A	Address Comments for Final EPA / TDEC Approval														
OO1210	Submit Copy of Approved Deliverable in the PDR (within 7 days following Receipt of Approval by EPA)	19	12-Mar-15 A	31-Mar-15 A	Submit Copy of Approved Deliverable in the PDR (within 7 days following Receipt of Approval by EPA)														
Maximizing Treatment at MBWWTP - Feasibility Analysis																			
Project Procurement																			
A11810	Project Procurement	104	01-Oct-23*	12-Jan-24	Project Procurement														
Planning Phase																			
A11820	Planning Phase	354	13-Jan-24	31-Dec-24	Planning Phase														
Project Closeout																			
A12970	Project Closeout	52	31-Dec-24	20-Feb-25	Project Closeout														
Para 25 - Moccasin Bend WWTP Process Controls Program																			
MBWWTP Process Controls Program																			
Consent Decree Duration (19 Months)																			
OP1110	Consent Decree Duration	579	24-Apr-13 A	24-Nov-14 A	Consent Decree Duration														
OP1120	Consent Decree Duration Completion Milestone	0		24-Nov-14 A	Consent Decree Duration Completion Milestone														
Project Procurement																			
OP1000	CD Prequalification Procurement (FY 2012 - 2013) Priority I - Development and Issuance of RFP	0	18-Oct-12 A	18-Oct-12 A	Prequalification Procurement (FY 2012 - 2013) Priority I - Development and Issuance of RFP														
OP1130	Consultant develops and Submit Scope and Cost proposal	10	18-Oct-12 A	27-Oct-12 A	Consultant develops and Submit Scope and Cost proposal														
OP1140	PMO Reviews/ Negotiates and Approve Proposal / Agreement	10	28-Oct-12 A	06-Nov-12 A	PMO Reviews/ Negotiates and Approve Proposal / Agreement														
OP1150	PMO Approved Agreement to Council for Approval	18	07-Nov-12 A	24-Nov-12 A	PMO Approved Agreement to Council for Approval														
OP1160	Consultant Signed Agreement to City for Execution	14	25-Nov-12 A	08-Dec-12 A	Consultant Signed Agreement to City for Execution														
Planning Phase																			
OP1010	Planning Phase	522	29-Apr-13 A	03-Oct-14 A	Planning Phase														

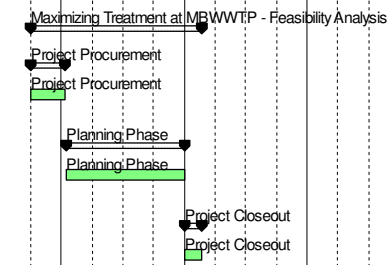

-  Summary
-  Actual Work
-  Remaining Work
-  Critical Remaining Work
-  Baseline Milestone

CHATTANOOGA CONSENT DECREE PROGRAM - PHASE I-2
 CITY OF CHATTANOOGA, TN
 WASTEWATER DEPARTMENT

Activity ID	Activity Name	At Completion Duration	Start	Finish	2013		2014		2015		2016		2017		2018		2019		2020		2021		2022		2023		2024		2025		2026					
					Q1	Q2	Q3	Q4	Q1	Q2	Q3	Q4	Q1	Q2	Q3	Q4	Q1	Q2	Q3	Q4	Q1	Q2	Q3	Q4	Q1	Q2	Q3	Q4	Q1	Q2	Q3	Q4	Q1	Q2	Q3	Q4
OP1190	Program Manager / Owner Review and Coordination	8	04-Oct-14 A	12-Oct-14 A																																
	Public Document Repository	36	13-Oct-14 A	18-Nov-14 A																																
OP1020	Submit Draft Deliverable to Reference Librarian	0	13-Oct-14 A	13-Oct-14 A																																
OP1030	Post Copy of Draft Deliverable on City's Website	3	13-Oct-14 A	16-Oct-14 A																																
OP1040	Public Review Period	35	13-Oct-14 A	17-Nov-14 A																																
OP1050	Public Comment Review Period	0	18-Nov-14 A	18-Nov-14 A																																
OP1060	Submit Deliverable to EPA, TDEC and Provide notice to TCWN	0	18-Nov-14 A	18-Nov-14 A																																
	EPA and TDEC Approvals	176	18-Nov-14 A	13-May-15 A																																
OP1070	Place Copy of EPA and TDEC Submittal in PDR	6	18-Nov-14 A	24-Nov-14 A																																
OP1080	EPA / TDEC Review	113	19-Nov-14 A	12-Mar-15 A																																
OP1090	Address Comments for Final EPA / TDEC Approval	60	13-Mar-15 A	12-May-15 A																																
OP1100	Submit Copy of Approved Deliverable in the PDR (within 7 days following Receipt of Approval by EPA)	0	13-May-15 A	13-May-15 A																																
Section VII - Civil Penalty		2130	01-Jan-13 A	01-Nov-18 A																																
Para 29 - Cash Fine		24	24-Apr-13 A	17-May-13 A																																
Cash Fine		24	24-Apr-13 A	17-May-13 A																																
Civil Penalty - 50% Cash Payment		24	24-Apr-13 A	17-May-13 A																																
CF1000	Pay 50% of Civil Penalty of \$238,200 to Dept of Justice by EFT	24	24-Apr-13 A	17-May-13 A																																
Para 30 - State Project (50% of Civil Penalty)		2130	01-Jan-13 A	01-Nov-18 A																																
Highland Park GI Demonstration Project		2130	01-Jan-13 A	01-Nov-18 A																																
Consent Decree Duration		2017	24-Apr-13 A	01-Nov-18 A																																
OR1030	Consent Decree Duration	2017	24-Apr-13 A	01-Nov-18 A																																
OR1040	Consent Decree Duration Completion Milestone	0		01-Nov-18 A																																
Project Procurement		0	24-Apr-13 A	24-Apr-13 A																																
OR1080	City Internal Performance	0	24-Apr-13 A	24-Apr-13 A																																
Task 1 - Planning Phase		479	01-Jan-13 A	25-Apr-14 A																																
OR1000	Project Plan	247	01-Jan-13 A	05-Sep-13 A																																
OR1005	Public Document Repository	47	06-Sep-13 A	23-Oct-13 A																																
OR1050	EPA Submittal	183	24-Oct-13 A	25-Apr-14 A																																
Task 2 - Engineering Phase		181	25-Apr-14 A	23-Oct-14 A																																
OR1010	EPA Project Plan Approval	0		25-Apr-14 A																																
OR1020	Detailed Design	146	25-Apr-14 A	18-Sep-14 A																																
OR1110	Public Document Repository	33	19-Sep-14 A	22-Oct-14 A																																
OR1120	EPA Submittal	0	23-Oct-14 A	23-Oct-14 A																																
Task 3 - Construction Bidding Phase		944	23-Oct-14 A	24-May-17 A																																
OR1060	EPA Detailed Design Approval	0		23-Oct-14 A																																
OR1180	3A - Bidding	943	24-Oct-14 A	24-May-17 A																																
Task 3: Construction Phase		328	25-May-17 A	18-Apr-18 A																																
OR1190	3B - Construction	328	25-May-17 A	18-Apr-18 A																																
Task 4 - GI Design Workshop		196	19-Apr-18 A	01-Nov-18 A																																

Summary
 Actual Work
 Remaining Work
 Critical Remaining Work
 Baseline Milestone

CHATTANOOGA CONSENT DECREE PROGRAM - PHASE I-2

CITY OF CHATTANOOGA, TN
WASTEWATER DEPARTMENT

Activity ID	Activity Name	At Completion Duration	Start	Finish	2013				2014				2015				2016				2017				2018				2019				2020				2021				2022				2023				2024				2025				2026			
					Q1	Q2	Q3	Q4	Q1	Q2	Q3	Q4	Q1	Q2	Q3	Q4	Q1	Q2	Q3	Q4	Q1	Q2	Q3	Q4	Q1	Q2	Q3	Q4	Q1	Q2	Q3	Q4	Q1	Q2	Q3	Q4	Q1	Q2	Q3	Q4	Q1	Q2	Q3	Q4	Q1	Q2	Q3	Q4	Q1	Q2	Q3	Q4								
CR1070	Place Copy of EPA and TDEC Submittal in PDR	0	10-Feb-14 A	10-Feb-14 A																																																								
	Quarterly Report - 2014	390	01-Jan-14 A	26-Jan-15 A																																																								
CR1080	Quarterly Report Period 3	89	01-Jan-14 A	31-Mar-14 A																																																								
CR1090	Develop Quarterly Report	27	01-Apr-14 A	28-Apr-14 A																																																								
CR1120	Quarterly Report Period 4	90	01-Apr-14 A	30-Jun-14 A																																																								
CR1100	Submit Deliverable to EPA and TDEC	0	29-Apr-14 A	29-Apr-14 A																																																								
CR1110	Place Copy of EPA and TDEC Submittal in PDR	0	29-Apr-14 A	29-Apr-14 A																																																								
CR1130	Develop Quarterly Report	28	30-Jun-14 A	28-Jul-14 A																																																								
CR1160	Quarterly Report Period 5	91	01-Jul-14 A	30-Sep-14 A																																																								
CR1140	Submit Deliverable to EPA and TDEC	0	29-Jul-14 A	29-Jul-14 A																																																								
CR1150	Place Copy of EPA and TDEC Submittal in PDR	0	29-Jul-14 A	29-Jul-14 A																																																								
CR1170	Develop Quarterly Report	29	30-Sep-14 A	29-Oct-14 A																																																								
CR1200	Quarterly Report Period 6	91	01-Oct-14 A	31-Dec-14 A																																																								
CR1180	Submit Deliverable to EPA and TDEC	0	29-Oct-14 A	29-Oct-14 A																																																								
CR1190	Place Copy of EPA and TDEC Submittal in PDR	0	29-Oct-14 A	29-Oct-14 A																																																								
CR1210	Develop Quarterly Report	26	31-Dec-14 A	26-Jan-15 A																																																								
CR1220	Submit Deliverable to EPA and TDEC	0	26-Jan-15 A	26-Jan-15 A																																																								
CR1230	Place Copy of EPA and TDEC Submittal in PDR	0	26-Jan-15 A	26-Jan-15 A																																																								
	Quarterly Report - 2015	395	01-Jan-15 A	31-Jan-16 A																																																								
CR1240	Quarterly Report Period 7	89	01-Jan-15 A	31-Mar-15 A																																																								
CR1250	Develop Quarterly Report 7	27	01-Apr-15 A	27-Apr-15 A																																																								
CR1280	Quarterly Report Period 8	90	01-Apr-15 A	30-Jun-15 A																																																								
CR1260	Submit Deliverable to EPA and TDEC	0	29-Apr-15 A	29-Apr-15 A																																																								
CR1270	Place Copy of EPA and TDEC Submittal in PDR	0	30-Apr-15 A	30-Apr-15 A																																																								
CR1290	Develop Quarterly Report 8	29	01-Jul-15 A	29-Jul-15 A																																																								
CR1320	Quarterly Report Period 9	91	01-Jul-15 A	30-Sep-15 A																																																								
CR1300	Submit Deliverable to EPA and TDEC	0	30-Jul-15 A	30-Jul-15 A																																																								
CR1310	Place Copy of EPA and TDEC Submittal in PDR	0	31-Jul-15 A	31-Jul-15 A																																																								
CR4210	Develop Quarterly Report 9	28	01-Oct-15 A	29-Oct-15 A																																																								
CR4240	Quarterly Report Period 10	91	01-Oct-15 A	31-Dec-15 A																																																								
CR4220	Submit Deliverable to EPA and TDEC	0	30-Oct-15 A	30-Oct-15 A																																																								
CR4230	Place Copy of EPA and TDEC Submittal in PDR	0	31-Oct-15 A	31-Oct-15 A																																																								
CR4250	Develop Quarterly Report 10	27	01-Jan-16 A	28-Jan-16 A																																																								
CR4260	Submit Deliverable to EPA and TDEC	0	29-Jan-16 A	29-Jan-16 A																																																								

 Summary
 Actual Work
 Remaining Work
 Critical Remaining Work
 Baseline Milestone

CHATTANOOGA CONSENT DECREE PROGRAM - PHASE I-2
CITY OF CHATTANOOGA, TN
WASTEWATER DEPARTMENT

Activity ID	Activity Name	At Completion Duration	Start	Finish	2013		2014		2015		2016		2017		2018		2019		2020		2021		2022		2023		2024		2025		2026									
					Q1	Q2	Q3	Q4	Q1	Q2	Q3	Q4	Q1	Q2	Q3	Q4	Q1	Q2	Q3	Q4	Q1	Q2	Q3	Q4	Q1	Q2	Q3	Q4	Q1	Q2	Q3	Q4	Q1	Q2	Q3	Q4				
CR83990	Place Copy of EPA and TDEC Submittal in PDR 66	0	31-Jan-30	31-Jan-30																																				
Quarterly Report - 2030		396	01-Jan-30	31-Jan-31																																				
CR84000	Quarterly Report Period 67	90	01-Jan-30*	31-Mar-30																																				
CR84010	Develop Quarterly Report 67	29	01-Apr-30	29-Apr-30																																				
CR84020	Quarterly Report Period 68	91	01-Apr-30	30-Jun-30																																				
CR84030	Submit Deliverable to EPA and TDEC 67	0	30-Apr-30	30-Apr-30																																				
CR84040	Place Copy of EPA and TDEC Submittal in PDR 67	0	30-Apr-30	30-Apr-30																																				
CR84050	Develop Quarterly Report 68	30	01-Jul-30	30-Jul-30																																				
CR84060	Quarterly Report Period 69	92	01-Jul-30	30-Sep-30																																				
CR84070	Submit Deliverable to EPA and TDEC 68	0	31-Jul-30	31-Jul-30																																				
CR84080	Place Copy of EPA and TDEC Submittal in PDR 68	0	31-Jul-30	31-Jul-30																																				
CR84090	Develop Quarterly Report 69	30	01-Oct-30	30-Oct-30																																				
CR84100	Quarterly Report Period 70	92	01-Oct-30*	31-Dec-30																																				
CR84110	Submit Deliverable to EPA and TDEC 69	0	31-Oct-30	31-Oct-30																																				
CR84120	Place Copy of EPA and TDEC Submittal in PDR 69	0	31-Oct-30	31-Oct-30																																				
CR84130	Develop Quarterly Report 70	31	01-Jan-31	31-Jan-31																																				
CR84140	Submit Deliverable to EPA and TDEC 70	0	31-Jan-31	31-Jan-31																																				
CR84150	Place Copy of EPA and TDEC Submittal in PDR 70	0	31-Jan-31	31-Jan-31																																				
Para 39 - Semi Annual Reports		6491	24-Apr-13 A	31-Jan-31	Para 39- Semi Annual Reports																																			
Semi Annual Reports		6491	24-Apr-13 A	31-Jan-31	Semi Annual Reports																																			
Semi-Annual Report - 2013		292	24-Apr-13 A	10-Feb-14 A	Semi-Annual Report - 2013																																			
CR4000	Semi Annual Report Period 1	252	24-Apr-13 A	31-Dec-13 A	Semi Annual Report Period 1																																			
CR4010	Develop Semi Annual Report	28	01-Jan-14 A	29-Jan-14 A	Develop Semi Annual Report																																			
CR4020	Submit Deliverable to EPA and TDEC	0	30-Jan-14 A	30-Jan-14 A	Submit Deliverable to EPA and TDEC																																			
CR4030	Place Copy of EPA and TDEC Submittal in PDR	0	10-Feb-14 A	10-Feb-14 A	Place Copy of EPA and TDEC Submittal in PDR																																			
Semi-Annual Report - 2014		392	01-Jan-14 A	28-Jan-15 A	Semi-Annual Report - 2014																																			
CR4040	Semi Annual Report Period 2	180	01-Jan-14 A	30-Jun-14 A	Semi Annual Report Period 2																																			
CR4050	Develop Semi Annual Report	27	01-Jul-14 A	28-Jul-14 A	Develop Semi Annual Report																																			
CR4080	Semi Annual Report Period 3	183	01-Jul-14 A	31-Dec-14 A	Semi Annual Report Period 3																																			
CR4060	Submit Deliverable to EPA and TDEC	0	29-Jul-14 A	29-Jul-14 A	Submit Deliverable to EPA and TDEC																																			
CR4070	Place Copy of EPA and TDEC Submittal in PDR	0	29-Jul-14 A	29-Jul-14 A	Place Copy of EPA and TDEC Submittal in PDR																																			
CR4090	Develop Semi Annual Report	27	31-Dec-14 A	27-Jan-15 A	Develop Semi Annual Report																																			
CR4100	Submit Deliverable to EPA and TDEC	0	27-Jan-15 A	27-Jan-15 A	Submit Deliverable to EPA and TDEC																																			
CR4110	Place Copy of EPA and TDEC Submittal in PDR	0	28-Jan-15 A	28-Jan-15 A	Place Copy of EPA and TDEC Submittal in PDR																																			
Semi-Annual Report - 2015		394	01-Jan-15 A	30-Jan-16 A	Semi-Annual Report - 2015																																			
CR4120	Semi Annual Report 4 Data Collection	180	01-Jan-15 A	30-Jun-15 A	Semi Annual Report 4 Data Collection																																			

- Summary
- Actual Work
- Remaining Work
- Critical Remaining Work
- Baseline Milestone

CHATTANOOGA CONSENT DECREE PROGRAM - PHASE I-2
CITY OF CHATTANOOGA, TN
WASTEWATER DEPARTMENT

Activity ID	Activity Name	At Completion Duration	Start	Finish	2013		2014		2015		2016		2017		2018		2019		2020		2021		2022		2023		2024		2025		2026				
					Q1	Q2	Q3	Q4	Q1	Q2	Q3	Q4	Q1	Q2	Q3	Q4	Q1	Q2	Q3	Q4	Q1	Q2	Q3	Q4	Q1	Q2	Q3	Q4	Q1	Q2	Q3	Q4	Q1	Q2	Q3
CR9280	Semi Annual Report 12 Data Collection	180	01-Jan-19 A	30-Jun-19 A													Semi Annual Report 12 Data Collection																		
CR9290	Develop Semi Annual Report 12	30	01-Jul-19 A	31-Jul-19 A												Develop Semi Annual Report 12																			
CR9320	Semi Annual Report 13 Data Collection	183	01-Jul-19 A	31-Dec-19 A												Semi Annual Report 13 Data Collection																			
CR9300	Submit Deliverable to EPA and TDEC	0	31-Jul-19 A	31-Jul-19 A												Submit Deliverable to EPA and TDEC																			
CR9310	Place Copy of EPA and TDEC Submittal in PDR	0	31-Jul-19 A	31-Jul-19 A												Place Copy of EPA and TDEC Submittal in PDR																			
CR9330	Develop Semi Annual Report 13	30	01-Jan-20 A	31-Jan-20 A												Develop Semi Annual Report 13																			
CR9340	Submit Deliverable to EPA and TDEC	0	31-Jan-20 A	31-Jan-20 A												Submit Deliverable to EPA and TDEC																			
CR9350	Place Copy of EPA and TDEC Submittal in PDR	0	31-Jan-20 A	31-Jan-20 A												Place Copy of EPA and TDEC Submittal in PDR																			
Annual Progress Report - 2020		396	01-Jan-20 A	31-Jan-21 A												Annual Progress Report - 2020																			
CR81400	Annual Progress Report 14 Data Collection	365	01-Jan-20 A	31-Dec-20 A												Annual Progress Report 14 Data Collection																			
CR81410	Develop Annual Progress Report 14	30	01-Jan-21 A	31-Jan-21 A												Develop Annual Progress Report 14																			
CR81420	Submit Deliverable to EPA and TDEC	0	31-Jan-21 A	31-Jan-21 A												Submit Deliverable to EPA and TDEC																			
CR81430	Place Copy of EPA and TDEC Submittal in PDR	0	31-Jan-21 A	31-Jan-21 A												Place Copy of EPA and TDEC Submittal in PDR																			
Annual Progress Report - 2021		1095	31-Jan-19 A	30-Jan-22 A												Annual Progress Report - 2021																			
CR84160	Annual Progress Report 15 Data Collection	1065	31-Jan-19 A	31-Dec-21 A												Annual Progress Report 15 Data Collection																			
CR84170	Develop Annual Progress Report 15	30	31-Dec-21 A	29-Jan-22 A												Develop Annual Progress Report 15																			
CR84180	Submit Deliverable to EPA and TDEC	0	30-Jan-22 A	30-Jan-22 A												Submit Deliverable to EPA and TDEC																			
CR84190	Place Copy of EPA and TDEC Submittal in PDR	0	30-Jan-22 A	30-Jan-22 A												Place Copy of EPA and TDEC Submittal in PDR																			
Annual Progress Report - 2022		395	01-Jan-22 A	31-Jan-23												Annual Progress Report - 2022																			
CR84200	Annual Progress Report 16 Data Collection	365	01-Jan-22 A	31-Dec-22												Annual Progress Report 16 Data Collection; Annual Progress Report 16 Data Collection																			
CR84210	Develop Annual Progress Report 16	30	01-Jan-23	30-Jan-23												Develop Annual Progress Report 16																			
CR84220	Submit Deliverable to EPA and TDEC	0	31-Jan-23	31-Jan-23												Submit Deliverable to EPA and TDEC																			
CR84230	Place Copy of EPA and TDEC Submittal in PDR	0	31-Jan-23	31-Jan-23												Place Copy of EPA and TDEC Submittal in PDR																			
Annual Progress Report - 2023		395	01-Jan-23	31-Jan-24												Annual Progress Report - 2023																			
CR84240	Annual Progress Report 17 Data Collection	365	01-Jan-23*	31-Dec-23												Annual Progress Report 17 Data Collection																			
CR84250	Develop Annual Progress Report 17	30	01-Jan-24	30-Jan-24												Develop Annual Progress Report 17																			
CR84260	Submit Deliverable to EPA and TDEC	0	31-Jan-24	31-Jan-24												Submit Deliverable to EPA and TDEC																			
CR84270	Place Copy of EPA and TDEC Submittal in PDR	0	31-Jan-24	31-Jan-24												Place Copy of EPA and TDEC Submittal in PDR																			
Annual Progress Report - 2024		396	01-Jan-24	31-Jan-25												Annual Progress Report - 2024																			
CR84280	Annual Progress Report 18 Data Collection	366	01-Jan-24*	31-Dec-24												Annual Progress Report 18 Data Collection																			
CR84290	Develop Annual Progress Report 18	30	01-Jan-25	30-Jan-25												Develop Annual Progress Report 18																			
CR84300	Submit Deliverable to EPA and TDEC	0	31-Jan-25	31-Jan-25												Submit Deliverable to EPA and TDEC																			
CR84310	Place Copy of EPA and TDEC Submittal in PDR	0	31-Jan-25	31-Jan-25												Place Copy of EPA and TDEC Submittal in PDR																			
Annual Progress Report - 2025		395	01-Jan-25	31-Jan-26												Annual Progress Report - 2025																			
CR84320	Annual Progress Report 19 Data Collection	365	01-Jan-25*	31-Dec-25												Annual Progress Report 19 Data Collection																			
CR84330	Develop Annual Progress Report 19	30	01-Jan-26	30-Jan-26												Develop Annual Progress Report 19																			

 Summary
 Actual Work
 Remaining Work
 Critical Remaining Work
 Baseline Milestone

CHATTANOOGA CONSENT DECREE PROGRAM - PHASE I-2
CITY OF CHATTANOOGA, TN
WASTEWATER DEPARTMENT

Activity ID	Activity Name	At Completion Duration	Start	Finish	2013		2014		2015		2016		2017		2018		2019		2020		2021		2022		2023		2024		2025		2026				
					Q1	Q2	Q3	Q4	Q1	Q2	Q3	Q4	Q1	Q2	Q3	Q4	Q1	Q2	Q3	Q4	Q1	Q2	Q3	Q4	Q1	Q2	Q3	Q4	Q1	Q2	Q3	Q4	Q1	Q2	Q3
CR84340	Submit Deliverable to EPA and TDEC	0	31-Jan-26	31-Jan-26																														Submit Deliverable	
CR84350	Place Copy of EPA and TDEC Submittal in PDR	0	31-Jan-26	31-Jan-26																														Place Copy of	
Annual Progress Report - 2026		395	01-Jan-26	31-Jan-27																													Annual Progress		
CR84360	Annual Progress Report 20 Data Collection	365	01-Jan-26*	31-Dec-26																													Annual Progress		
CR84370	Develop Annual Progress Report 20	30	01-Jan-27	30-Jan-27																															
CR84380	Submit Deliverable to EPA and TDEC	0	31-Jan-27	31-Jan-27																															
CR84390	Place Copy of EPA and TDEC Submittal in PDR	0	31-Jan-27	31-Jan-27																															
Annual Progress Report - 2027		395	01-Jan-27	31-Jan-28																															
CR84400	Annual Progress Report 21 Data Collection	365	01-Jan-27*	31-Dec-27																															
CR84410	Develop Annual Progress Report 21	30	01-Jan-28	30-Jan-28																															
CR84420	Submit Deliverable to EPA and TDEC	0	31-Jan-28	31-Jan-28																															
CR84430	Place Copy of EPA and TDEC Submittal in PDR	0	31-Jan-28	31-Jan-28																															
Annual Progress Report - 2028		396	01-Jan-28	31-Jan-29																															
CR84440	Annual Progress Report 22 Data Collection	366	01-Jan-28*	31-Dec-28																															
CR84450	Develop Annual Progress Report 22	30	01-Jan-29	30-Jan-29																															
CR84460	Submit Deliverable to EPA and TDEC	0	31-Jan-29	31-Jan-29																															
CR84470	Place Copy of EPA and TDEC Submittal in PDR	0	31-Jan-29	31-Jan-29																															
Annual Progress Report - 2029		395	01-Jan-29	31-Jan-30																															
CR84480	Annual Progress Report 23 Data Collection	365	01-Jan-29*	31-Dec-29																															
CR84490	Develop Annual Progress Report 23	30	01-Jan-30	30-Jan-30																															
CR84500	Submit Deliverable to EPA and TDEC	0	31-Jan-30	31-Jan-30																															
CR84510	Place Copy of EPA and TDEC Submittal in PDR	0	31-Jan-30	31-Jan-30																															
Annual Progress Report - 2030		395	01-Jan-30	31-Jan-31																															
CR84520	Annual Progress Report 24 Data Collection	365	01-Jan-30*	31-Dec-30																															
CR84530	Develop Annual Progress Report 24	30	01-Jan-31	30-Jan-31																															
CR84540	Submit Deliverable to EPA and TDEC	0	31-Jan-31	31-Jan-31																															
CR84550	Place Copy of EPA and TDEC Submittal in PDR	0	31-Jan-31	31-Jan-31																															
Para 40 - Annual Reports		6268	01-Jan-14 A	28-Feb-31																															
Annual Reports		6268	01-Jan-14 A	28-Feb-31																															
Annual Report - 2013		58	01-Jan-14 A	28-Feb-14 A																															
CR8010	Develop Annual Report	56	01-Jan-14 A	26-Feb-14 A																															
CR8020	Submit Deliverable to EPA and TDEC	0	27-Feb-14 A	27-Feb-14 A																															
CR8030	Place Copy of EPA and TDEC Submittal in PDR	0	28-Feb-14 A	28-Feb-14 A																															
Annual Report - 2014		420	01-Jan-14 A	25-Feb-15 A																															
CR8040	Annual Report Period 2	364	01-Jan-14 A	31-Dec-14 A																															
CR8050	Develop Annual Report	55	31-Dec-14 A	24-Feb-15 A																															
CR8060	Submit Deliverable to EPA and TDEC	0	25-Feb-15 A	25-Feb-15 A																															

- Summary
- Actual Work
- Remaining Work
- Critical Remaining Work
- Baseline Milestone

CHATTANOOGA CONSENT DECREE PROGRAM - PHASE I-2
CITY OF CHATTANOOGA, TN
WASTEWATER DEPARTMENT

Activity ID	Activity Name	At Completion Duration	Start	Finish	2013				2014				2015				2016				2017				2018				2019				2020				2021				2022				2023				2024				2025				2026			
					Q1	Q2	Q3	Q4	Q1	Q2	Q3	Q4	Q1	Q2	Q3	Q4	Q1	Q2	Q3	Q4	Q1	Q2	Q3	Q4	Q1	Q2	Q3	Q4	Q1	Q2	Q3	Q4	Q1	Q2	Q3	Q4	Q1	Q2	Q3	Q4	Q1	Q2	Q3	Q4	Q1	Q2	Q3	Q4	Q1	Q2	Q3	Q4								
South Chick PS Phase II and Spring Creek PS Upgrades																																																												
Project Procurement																																																												
A2000	CD Prequalification Procurement (FY 2014 - 2015) - Development and Issuance of RFP	29	21-Aug-14 A	19-Sep-14 A																																																								
A2020	Consultant develops and Submit Scope and Cost proposal	23	20-Sep-14 A	13-Oct-14 A																																																								
A2030	PMO Reviews/ Negotiates and Approve Proposal / Agreement	163	14-Oct-14 A	26-Mar-15 A																																																								
A2040	PMO Approved Agreement to Council for Approval	4	27-Mar-15 A	31-Mar-15 A																																																								
A2050	Consultant Signed Agreement to City for Execution	34	01-Apr-15 A	05-May-15 A																																																								
Planning Phase																																																												
A2200	Planning Phase	283	06-May-15 A	12-Feb-16 A																																																								
Engineering Phase																																																												
A2300	Engineering Phase	117	24-Feb-16 A	20-Jun-16 A																																																								
A2400	SRF Approval of Contract Documents	43	21-Jun-16 A	03-Aug-16 A																																																								
Construction Bidding Phase																																																												
A2500	Construction Bidding Phase	54	04-Aug-16 A	27-Sep-16 A																																																								
A2600	SRF Administration Phase	26	28-Sep-16 A	24-Oct-16 A																																																								
Construction Phase																																																												
A2700	Construction Phase	165	27-Oct-16 A	10-Apr-17 A																																																								
Carter Street Sewer Rehab																																																												
Carter Street Sewer Rehabilitation																																																												
Project Procurement																																																												
A11130	Previously Procured Consent Decree Projects	0	07-Sep-12 A	07-Sep-12 A																																																								
Planning Phase																																																												
A11140	Planning Phase	3	13-Jan-16 A	15-Jan-16 A																																																								
A11150	SRF Facility Plan Approval	4	16-Jan-16 A	19-Jan-16 A																																																								
Engineering Phase																																																												
A11160	Engineering	37	13-Jan-16 A	18-Feb-16 A																																																								
A11170	SRF Approval of Contract Documents	42	19-Feb-16 A	01-Apr-16 A																																																								
Construction Bidding Phase																																																												
A11180	Construction Bidding Phase	78	04-Apr-16 A	21-Jun-16 A																																																								
A11190	SRF Administration Phase	0	17-Jun-16 A	17-Jun-16 A																																																								
Construction Phase																																																												
A11200	Construction Phase	126	24-Aug-16 A	28-Dec-16 A																																																								
MBWWTP Control Room Upgrade																																																												
MBWWTP Control Room Upgrades																																																												
A4390	Project Execution	1739	30-Nov-15 A	03-Sep-20 A																																																								
Planning Phase																																																												
A4400	Planning	358	01-Dec-15 A	23-Nov-16 A																																																								
Engineering Phase																																																												
A4410	Engineering	222	05-Oct-16 A	15-May-17 A																																																								
Construction Bidding Phase																																																												
A4410	Construction Bidding Phase	220	16-May-17 A	22-Dec-17 A																																																								

Summary
 Actual Work
 Remaining Work
 Critical Remaining Work
 Baseline Milestone

CHATTANOOGA CONSENT DECREE PROGRAM - PHASE I-2
CITY OF CHATTANOOGA, TN
WASTEWATER DEPARTMENT

Activity ID	Activity Name	At Completion Duration	Start	Finish	2013				2014				2015				2016				2017				2018				2019				2020				2021				2022				2023				2024				2025				2026			
					Q1	Q2	Q3	Q4	Q1	Q2	Q3	Q4	Q1	Q2	Q3	Q4	Q1	Q2	Q3	Q4	Q1	Q2	Q3	Q4	Q1	Q2	Q3	Q4	Q1	Q2	Q3	Q4	Q1	Q2	Q3	Q4	Q1	Q2	Q3	Q4	Q1	Q2	Q3	Q4	Q1	Q2	Q3	Q4	Q1	Q2	Q3	Q4								
Construction Bidding Phase																																																												
A4640	Construction Bidding Phase	91	06-Nov-18 A	24-Mar-19 A																																																								
A4645	SRF Administration Phase	46	06-Feb-19 A	24-Mar-19 A																																																								
Construction Phase																																																												
A4650	Construction Phase	1468	25-Mar-19 A	31-Mar-23																																																								
Project Closeout																																																												
A4670	Project Closeout	60	01-Apr-23	30-May-23																																																								
CSOTF Improvements - Phase 1																																																												
CSOTF Improvements - Phase 1																																																												
Project Procurement Phase																																																												
A8720	Project Procurement Phase	350	01-Dec-17 A	16-Nov-18 A																																																								
Planning Phase																																																												
A8730	Planning Phase	370	17-Nov-18 A	22-Nov-19 A																																																								
Engineering Phase																																																												
A8740	Engineering Phase	422	24-Mar-20 A	20-May-21 A																																																								
Construction Bidding Phase																																																												
A8750	Construction Bidding Phase	142	22-Jun-21 A	11-Nov-21 A																																																								
Construction Phase																																																												
A8760	Construction Phase	685	11-Nov-21 A	26-Sep-23																																																								
Project Closeout																																																												
A8770	Project Closeout	34	27-Sep-23	30-Oct-23																																																								
CSOTF Equipment Replacement Program (FY20)																																																												
CSOTF Equipment Replacement Program (FY20)																																																												
Project Procurement																																																												
A10730	Procurement Phase	190	01-Jul-19 A	07-Jan-20 A																																																								
Planning Phase																																																												
A10740	Planning Phase	68	08-Jan-20 A	16-Mar-20 A																																																								
Engineering Phase																																																												
A11580	Engineering Phase	499	17-Mar-20 A	29-Jul-21 A																																																								
Construction Bidding Phase																																																												
A11640	Construction Bidding Phase	153	16-Jun-21 A	16-Nov-21 A																																																								
Construction Phase																																																												
A11650	Construction Phase	563	17-Nov-21 A	02-Jun-23																																																								
Project Closeout																																																												
A12900	Project Closeout	0	03-Jun-23	03-Jun-23																																																								
Dobbs Branch Basin Improvements - Phase 1																																																												
Dobbs Branch Basin Improvements - Phase 1																																																												
Project Procurement Phase																																																												
A8170	Procurement Phase	304	01-Dec-17 A	01-Oct-18 A																																																								
Planning Phase																																																												
A8180	Planning Phase	177	02-Oct-18 A	28-Mar-19 A																																																								
Engineering Phase																																																												
A8190	Engineering Phase	136	29-Mar-19 A	12-Aug-19 A																																																								

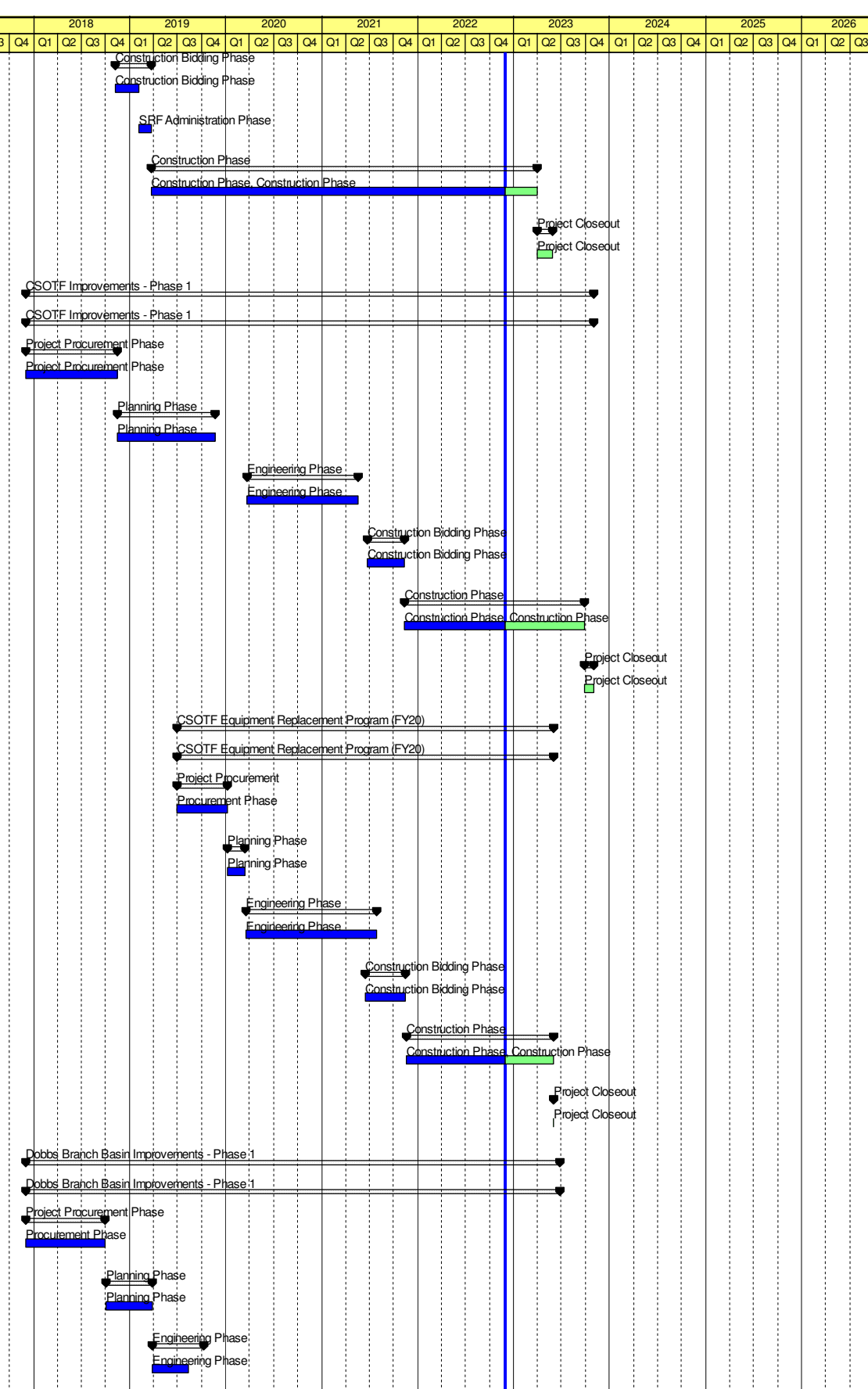

CHATTANOOGA CONSENT DECREE PROGRAM - PHASE I-2
CITY OF CHATTANOOGA, TN
WASTEWATER DEPARTMENT

Activity ID	Activity Name	At Completion Duration	Start	Finish	2013				2014				2015				2016				2017				2018				2019				2020				2021				2022				2023				2024				2025				2026			
					Q1	Q2	Q3	Q4	Q1	Q2	Q3	Q4	Q1	Q2	Q3	Q4	Q1	Q2	Q3	Q4	Q1	Q2	Q3	Q4	Q1	Q2	Q3	Q4	Q1	Q2	Q3	Q4	Q1	Q2	Q3	Q4	Q1	Q2	Q3	Q4	Q1	Q2	Q3	Q4	Q1	Q2	Q3	Q4												
Construction Bidding Phase																																																												
A10240	Construction Bidding Phase	373	22-Nov-21 A	30-Nov-22 A																																																								
Construction Phase																																																												
A10250	Construction Phase	548	09-Nov-22 A	09-May-24																																																								
Project Closeout																																																												
A10510	Project Closeout	61	10-May-24	09-Jul-24																																																								
Riverview Park/CGCC Chronic SSO Elimination Project																																																												
Riverview Park/CGCC Chronic SSO Elimination Project																																																												
Project Procurement Phase																																																												
A10110	Project Procurement Phase	159	01-Jun-19 A	07-Nov-19 A																																																								
Planning Phase																																																												
A10120	Planning Phase	188	08-Nov-19 A	14-May-20 A																																																								
Engineering Phase																																																												
A10130	Engineering Phase	228	15-May-20 A	29-Dec-20 A																																																								
Construction Bidding Phase																																																												
A10140	Construction Bidding Phase	95	21-Jan-21 A	26-Apr-21 A																																																								
Construction Phase																																																												
A10150	Construction Phase	1071	26-Apr-21 A	31-Mar-24																																																								
Project Closeout																																																												
A10490	Project Closeout	61	01-Apr-24	31-May-24																																																								
South Chic 2, 3, & 4 Interceptor Rehabilitation																																																												
South Chic Creek 2, 3, & 4 Rehabilitation / South Chic 2-4 Interceptor Rehab																																																												
Project Procurement																																																												
A9720	Procurement Phase	422	01-Jun-18 A	28-Jul-19 A																																																								
Planning Phase																																																												
A9730	Planning Phase	360	29-Jul-19 A	23-Jul-20 A																																																								
Engineering Phase																																																												
A9740	Engineering Phase	441	24-Jul-20 A	08-Oct-21 A																																																								
Construction Bidding Phase																																																												
A9750	Construction Bidding Phase	262	11-Oct-21 A	30-Jun-22 A																																																								
Construction Phase																																																												
A9760	Construction Phase	615	25-May-22 A	29-Jan-24																																																								
Project Closeout																																																												
A9830	Project Closeout	60	30-Jan-24	29-Mar-24																																																								
Tiftonia PS #1 Safety Upgrade																																																												
Tiftonia PS #1 Safety Upgrade																																																												
Project Procurement																																																												
A10380	Project Procurement Phase	267	01-Jul-19 A	24-Mar-20 A																																																								
Planning Phase																																																												
A10390	Planning Phase	158	24-Mar-20 A	29-Aug-20 A																																																								
ISS Capacity Improvements - Creekside Preserve																																																												
ISS Capacity Improvement - Creekside Preserve																																																												
Project Procurement																																																												

Summary
 Actual Work
 Remaining Work
 Critical Remaining Work
 Baseline Milestone

CHATTANOOGA CONSENT DECREE PROGRAM - PHASE I-2
CITY OF CHATTANOOGA, TN
WASTEWATER DEPARTMENT

Activity ID	Activity Name	At Completion Duration	Start	Finish	2013		2014				2015				2016				2017				2018				2019				2020				2021				2022				2023				2024				2025				2026			
					Q1	Q2	Q3	Q4	Q1	Q2	Q3	Q4	Q1	Q2	Q3	Q4	Q1	Q2	Q3	Q4	Q1	Q2	Q3	Q4	Q1	Q2	Q3	Q4	Q1	Q2	Q3	Q4	Q1	Q2	Q3	Q4	Q1	Q2	Q3	Q4	Q1	Q2	Q3	Q4	Q1	Q2	Q3	Q4										
Engineering Phase					845	27-Mar-23	18-Jul-25																																																			
A118270	Engineering Phase	845	27-Mar-23*	18-Jul-25																																																						
Construction Phase					610	23-Dec-24	24-Aug-26																																																			
A118280	Construction	610	23-Dec-24*	24-Aug-26																																																						
Project Closeout					68	24-Aug-26	30-Oct-26																																																			
A118290	Project Closeout	68	24-Aug-26*	30-Oct-26																																																						
Tiftonia PS #2 Safety Upgrade					1341	01-Oct-20 A	02-Jun-24																																																			
Tiftonia PS #2 Safety Upgrade					1341	01-Oct-20 A	02-Jun-24																																																			
Project Procurement					103	01-Oct-20 A	12-Jan-21 A																																																			
A10680	Project Procurement Phase	103	01-Oct-20 A	12-Jan-21 A																																																						
Planning Phase					238	13-Jan-21 A	08-Sep-21 A																																																			
A10690	Planning Phase	238	13-Jan-21 A	08-Sep-21 A																																																						
Engineering Phase					277	09-Sep-21 A	13-Jun-22 A																																																			
A10700	Engineering Phase	277	09-Sep-21 A	13-Jun-22 A																																																						
Construction Bidding Phase					90	01-Feb-23	01-May-23																																																			
A10710	Construction Bidding Phase	90	01-Feb-23*	01-May-23																																																						
Construction Phase					366	02-May-23	01-May-24																																																			
A10720	Construction Phase	366	02-May-23	01-May-24																																																						
Project Closeout					32	02-May-24	02-Jun-24																																																			
A10840	Project Closeout	32	02-May-24	02-Jun-24																																																						
SCADA Master Plan					1002	31-Dec-19 A	27-Sep-22 A																																																			
SCADA Master Plan					1002	31-Dec-19 A	27-Sep-22 A																																																			
Planning Phase					941	31-Dec-19 A	29-Jul-22 A																																																			
A118050	Planning	941	31-Dec-19 A	29-Jul-22 A																																																						
Project Closeout					60	30-Jul-22 A	27-Sep-22 A																																																			
A118240	Project Closeout	60	30-Jul-22 A	27-Sep-22 A																																																						
MBWWTP Improvements - Centrifuge Upgrades					1010	04-Jun-20 A	10-Mar-23																																																			
MBWWTP Improvements - Centrifuge Upgrades					1010	04-Jun-20 A	10-Mar-23																																																			
Planning Phase					197	04-Jun-20 A	18-Dec-20 A																																																			
A11710	Planning Phase	197	04-Jun-20 A	18-Dec-20 A																																																						
Engineering Phase					206	31-Aug-21 A	25-Mar-22 A																																																			
A11720	Engineering Phase	206	31-Aug-21 A	25-Mar-22 A																																																						
Construction Bidding Phase					91	26-Mar-22 A	24-Jun-22 A																																																			
A11730	Construction Bidding Phase	91	26-Mar-22 A	24-Jun-22 A																																																						
Construction Phase					199	25-Jun-22 A	09-Jan-23																																																			
A118120	Construction Phase	199	25-Jun-22 A	09-Jan-23																																																						
Project Closeout					60	10-Jan-23	10-Mar-23																																																			
A118230	Project Closeout	60	10-Jan-23	10-Mar-23																																																						
Citico Force Main Replacement / Tremont Sewer Separation Implementation					1248	01-Jul-19 A	30-Nov-22																																																			
Citico Force Main Replacement / Tremont Sewer Separation Implementation					1248	01-Jul-19 A	30-Nov-22																																																			
Project Procurement					183	01-Jul-19 A	31-Dec-19 A																																																			
A8070	Procurement Phase	183	01-Jul-19 A	31-Dec-19 A																																																						
Planning Phase					304	01-Jan-20 A	31-Oct-20 A																																																			
A8080	Planning Phase	304	01-Jan-20 A	31-Oct-20 A																																																						

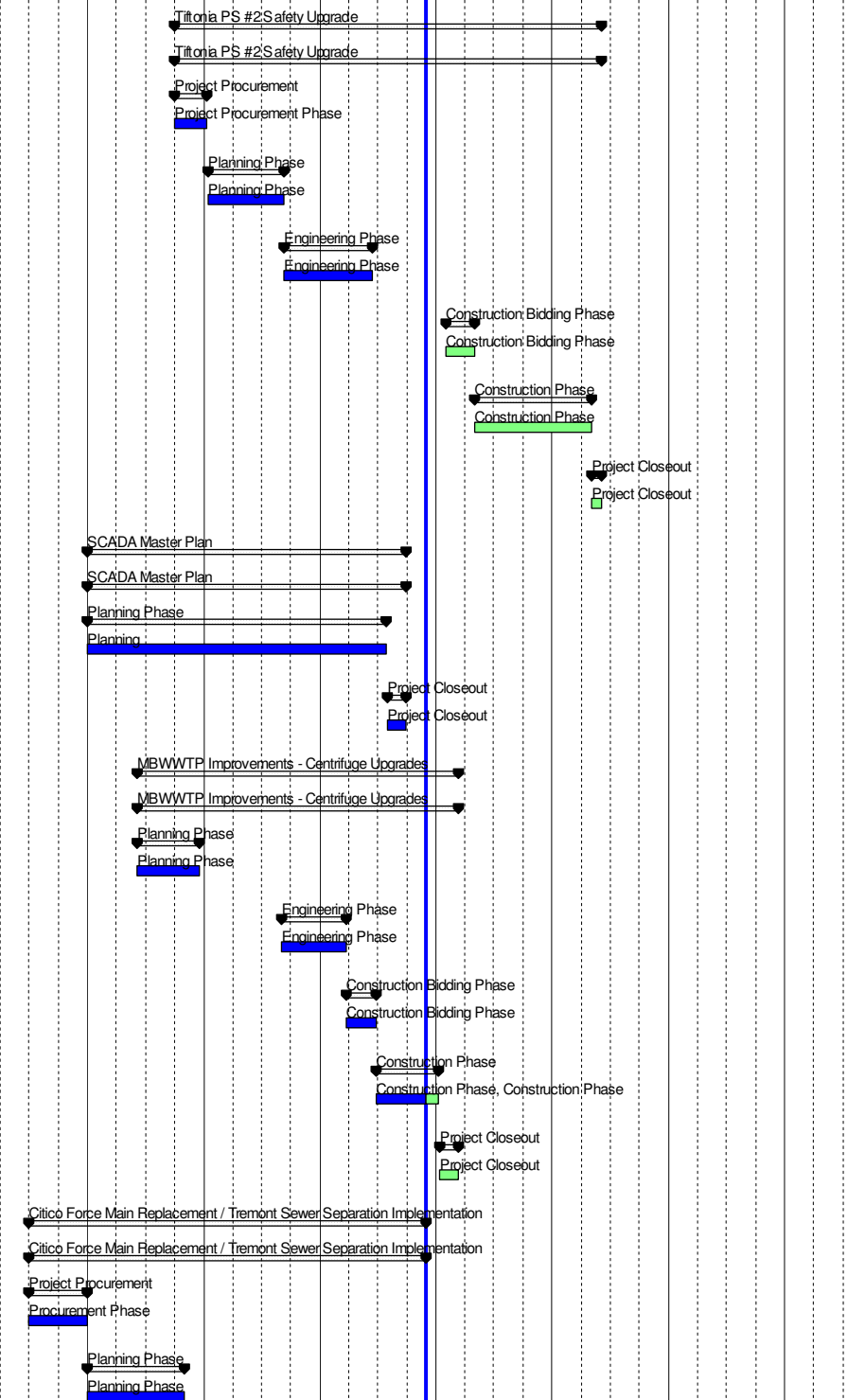

CHATTANOOGA CONSENT DECREE PROGRAM - PHASE I-2
CITY OF CHATTANOOGA, TN
WASTEWATER DEPARTMENT

Activity ID	Activity Name	At Completion Duration	Start	Finish	2013				2014				2015				2016				2017				2018				2019				2020				2021				2022				2023				2024				2025				2026			
					Q1	Q2	Q3	Q4	Q1	Q2	Q3	Q4	Q1	Q2	Q3	Q4	Q1	Q2	Q3	Q4	Q1	Q2	Q3	Q4	Q1	Q2	Q3	Q4	Q1	Q2	Q3	Q4	Q1	Q2	Q3	Q4	Q1	Q2	Q3	Q4	Q1	Q2	Q3	Q4	Q1	Q2	Q3	Q4	Q1	Q2	Q3	Q4								
Engineering Phase					149	01-Nov-21 A	30-Mar-22 A																																																					
A8090	Engineering Phase	149	01-Nov-21 A	30-Mar-22 A																																																								
Construction Bidding Phase					0	30-Nov-22	30-Nov-22																																																					
A8100	Construction Bidding Phase (TBD)	0	30-Nov-22*	30-Nov-22																																																								
Construction Phase					0	30-Nov-22	30-Nov-22																																																					
A8110	Construction Phase (TBD)	0	30-Nov-22	30-Nov-22																																																								
Project Closeout					0	30-Nov-22	30-Nov-22																																																					
A8140	Project Closeout (TBD)	0	30-Nov-22	30-Nov-22																																																								
Mountain Creek PS Improvements					914	01-Mar-20 A	31-Aug-22 A																																																					
Mountain Creek PS Improvements					914	01-Mar-20 A	31-Aug-22 A																																																					
Project Procurement					79	01-Mar-20 A	19-May-20 A																																																					
A10060	Project Procurement Phase	79	01-Mar-20 A	19-May-20 A																																																								
Planning Phase					20	19-May-20 A	08-Jun-20 A																																																					
A10070	Planning Phase	20	19-May-20 A	08-Jun-20 A																																																								
Engineering Phase					172	23-Jul-20 A	11-Jan-21 A																																																					
A10080	Engineering Phase	172	23-Jul-20 A	11-Jan-21 A																																																								
Construction Phase					500	12-Jan-21 A	27-May-22 A																																																					
A10100	Construction Phase	500	12-Jan-21 A	27-May-22 A																																																								
Project Closeout					97	27-May-22 A	31-Aug-22 A																																																					
A10420	Project Closeout	97	27-May-22 A	31-Aug-22 A																																																								
Pump Station Improvements (FY21)					1126	03-Mar-21 A	01-Apr-24																																																					
Pump Station Improvements Big Ridge #5 (FY21)					1126	03-Mar-21 A	01-Apr-24																																																					
Planning Phase					308	03-Mar-21 A	05-Jan-22 A																																																					
A9120	Planning Phase	308	03-Mar-21 A	05-Jan-22 A																																																								
Engineering Phase					392	06-Jan-22 A	01-Feb-23																																																					
A9130	Engineering Phase	392	06-Jan-22 A	01-Feb-23																																																								
Construction Bidding Phase					222	24-Dec-22 A	02-Aug-23																																																					
A9140	Construction Bidding Phase	222	24-Dec-22 A	02-Aug-23																																																								
Construction Phase					183	03-Aug-23	01-Feb-24																																																					
A9150	Construction Phase	183	03-Aug-23	01-Feb-24																																																								
Project Closeout					31	02-Mar-24*	01-Apr-24																																																					
A9160	Project Closeout	31	02-Mar-24*	01-Apr-24																																																								
Big Ridge PS #2 Improvements					705	01-Jan-22 A	06-Dec-23																																																					
Big Ridge PS #2 Improvements					705	01-Jan-22 A	06-Dec-23																																																					
Project Procurement					36	01-Jan-22 A	06-Feb-22 A																																																					
A10580	Project Procurement Phase	36	01-Jan-22 A	06-Feb-22 A																																																								
Planning Phase					41	07-Feb-22 A	20-Mar-22 A																																																					
A10590	Planning Phase	41	07-Feb-22 A	20-Mar-22 A																																																								
Engineering Phase					361	21-Mar-22 A	16-Mar-23																																																					
A10600	Engineering Phase	361	21-Mar-22 A	16-Mar-23																																																								
Construction Bidding Phase					76	17-Mar-23	31-May-23																																																					
A10610	Construction Bidding Phase	76	17-Mar-23	31-May-23																																																								
Construction Phase					91	01-Aug-23	30-Oct-23																																																					

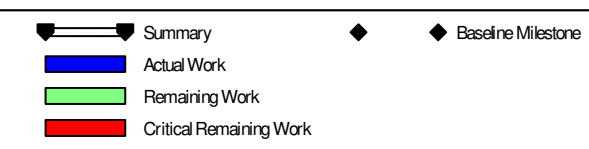
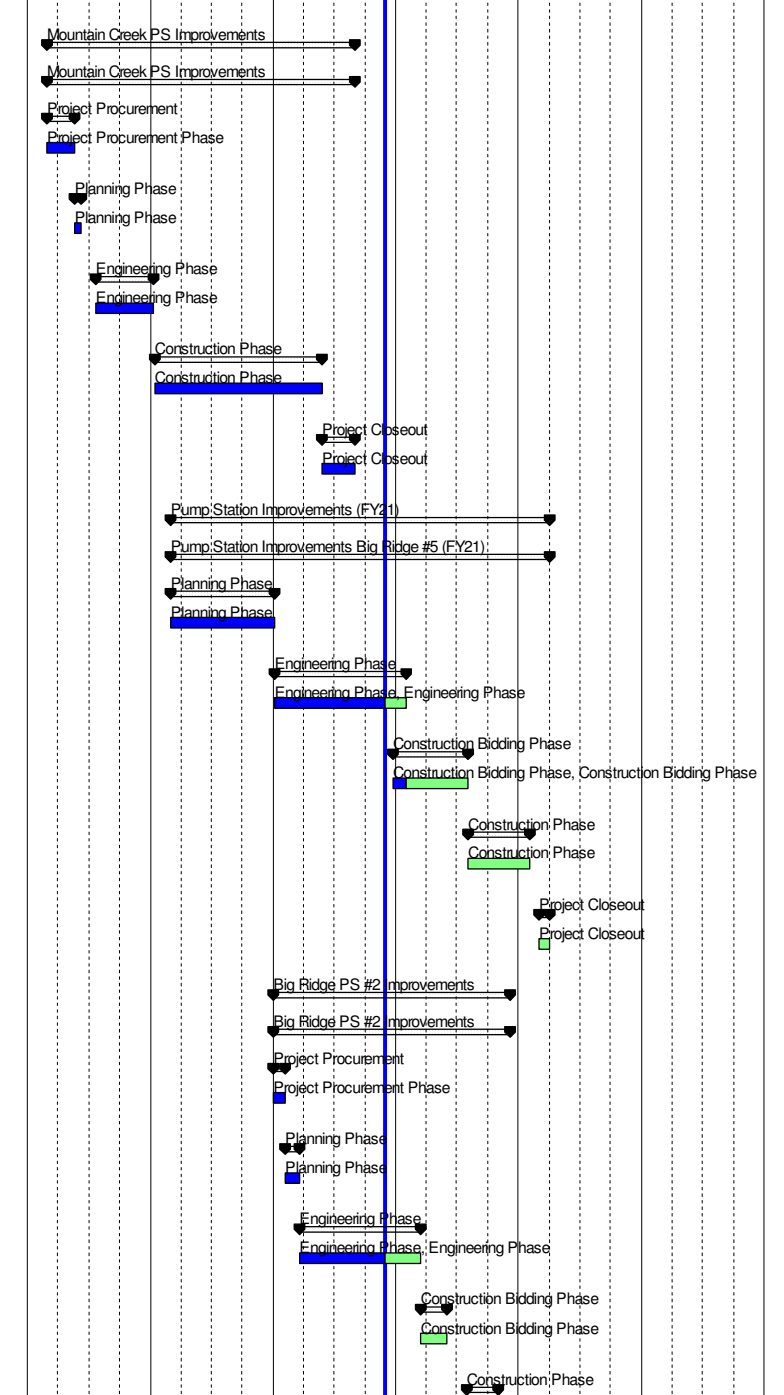

CHATTANOOGA CONSENT DECREE PROGRAM - PHASE I-2
CITY OF CHATTANOOGA, TN
WASTEWATER DEPARTMENT

Activity ID	Activity Name	At Completion Duration	Start	Finish	2013				2014				2015				2016				2017				2018				2019				2020				2021				2022				2023				2024				2025				2026			
					Q1	Q2	Q3	Q4	Q1	Q2	Q3	Q4	Q1	Q2	Q3	Q4	Q1	Q2	Q3	Q4	Q1	Q2	Q3	Q4	Q1	Q2	Q3	Q4	Q1	Q2	Q3	Q4	Q1	Q2	Q3	Q4	Q1	Q2	Q3	Q4	Q1	Q2	Q3	Q4	Q1	Q2	Q3	Q4	Q1	Q2	Q3	Q4								
Project Procurement																																																												
A118070	Project Procurement	30	03-Jan-22 A	01-Feb-22 A																																																								
Planning Phase																																																												
A118080	Planning Phase	310	02-Feb-22 A	08-Dec-22																																																								
Engineering Phase																																																												
A118090	Engineering Phase	135	09-Dec-22 A	22-Apr-23																																																								
Construction Bidding Phase																																																												
A118100	Bidding Phase	56	23-Apr-23*	17-Jun-23																																																								
Construction Phase																																																												
A118110	Construction Phase	240	18-Jun-23	12-Feb-24																																																								
Project Closeout																																																												
A118220	Project Closeout	29	13-Feb-24	12-Mar-24																																																								
Tiftonia Pump Station #3 Improvements																																																												
Tiftonia Pump Station #3 Improvements																																																												
Planning Phase																																																												
A5000	Planning Phase	117	30-Oct-22 A	23-Feb-23																																																								
Engineering Phase																																																												
A5010	Engineering Phase	169	24-Feb-23	11-Aug-23																																																								
Project Closeout																																																												
A5020	Project Closeout	60	12-Aug-23	10-Oct-23																																																								
South chick pump station improvements																																																												
South chick pump station improvements																																																												
Procurement																																																												
A11800	Procurement	69	01-Sep-22 A	09-Nov-22 A																																																								
Project Planning																																																												
A11740	Planning Phase	152	09-Nov-22 A	09-Apr-23																																																								
Design																																																												
A11930	Design Phase	184	09-Apr-23	09-Oct-23																																																								
Construction Bid																																																												
A11940	Bidding Phase	84	09-Oct-23	31-Dec-23																																																								
Construction																																																												
A11950	Construction Phase	306	01-Jan-24	01-Nov-24																																																								
Project Closeout																																																												
A11970	Project Closeout	61	01-Nov-24	31-Dec-24																																																								
Green Infrastructure - Lincoln Park																																																												
Green Infrastructure - Lincoln Park																																																												
Planning Phase																																																												
A9320	Planning	578	01-Jun-21 A	30-Dec-22 A																																																								
Design Phase																																																												
A9330	Design	244	01-Jan-23	01-Sep-23																																																								
Construction Phase																																																												
A9270	Construction	365	01-Sep-23	30-Aug-24																																																								
Project Closeout																																																												

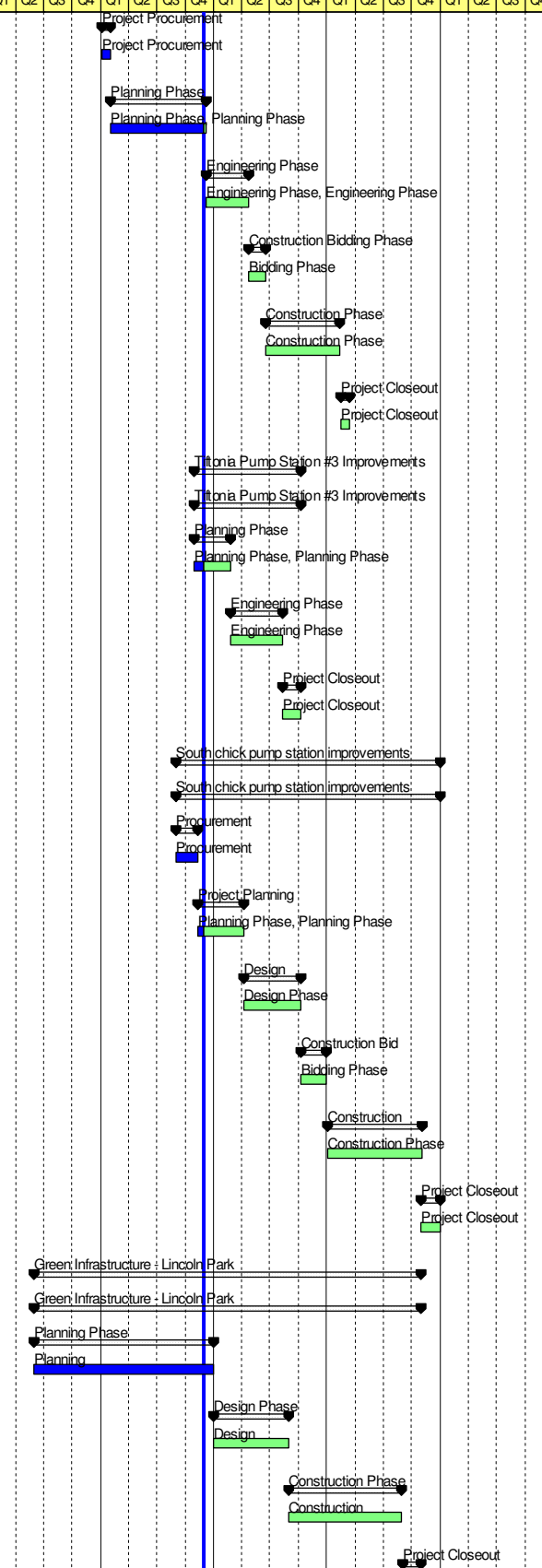

CHATTANOOGA CONSENT DECREE PROGRAM - PHASE I-2
CITY OF CHATTANOOGA, TN
WASTEWATER DEPARTMENT

